

# User Manual

## DC Charger

IDC30E





# All Rights Reserved

## All Rights Reserved

No part of this document can be reproduced in any form or by any means without the prior written permission of Sungrow Power Supply Co., Ltd (hereinafter "SUNGROW").

## Trademarks

**SUNGROW** and other Sungrow trademarks used in this manual are owned by SUNGROW.

All other trademarks or registered trademarks mentioned in this manual are owned by their respective owners.

## Software Licenses

- It is prohibited to use data contained in firmware or software developed by SUNGROW, in part or in full, for commercial purposes by any means.
- It is prohibited to perform reverse engineering, cracking, or any other operations that compromise the original program design of the software developed by SUNGROW.

## Privacy Protection

- Information contained in this manual is the private property of Sungrow Power Supply Co., Ltd. Internal reproduction is allowed only for product evaluation or other appropriate purposes.
- We declare that the network account and password data stored in the equipment system are only used for remote control and monitoring of the equipment and will not be transmitted to any third-party data platform without your permission.

## Disposal

After the service life of the charger ends, please dispose of it in accordance with the applicable electrical waste disposal act at the installation location. It can also be returned to Sungrow, but the relevant expenses shall be borne by your party.

# About This Manual

The manual mainly contains product information, as well as guidelines for installation, operation, and maintenance.

## Target Group

This manual is intended for professional technicians who are responsible for installation, operation, and maintenance of the charger, and users who need to check charger parameters.

A professional technician is required to meet the following requirements:

- Know electronic, electrical wiring, and mechanical expertise, and be familiar with electrical and mechanical circuit diagrams.
- Have received professional training related to installation and commissioning of electrical equipment.
- Be able to quickly respond to hazards or emergencies that occur during installation and commissioning.
- Be familiar with local standards and relevant safety regulations of electrical systems.
- Read this manual thoroughly and understand the safety instructions related to operations.

## EMC

In some cases, even if the equipment is in accordance with the standard emission limits, it can have an impact in certain application areas (some sensitive equipment is placed in the same location; the equipment is installed close to a radio or TV receiver), and the operator shall take appropriate action to correct this situation.

## How to Use This Manual

Please read this manual carefully before using the product and keep it properly at a place for easy access.

All contents, pictures, marks, and symbols in this manual are owned by SUNGROW. No part of this document may be reprinted by the non-internal staff of SUNGROW without written authorization.

Contents of this manual may be periodically updated or revised, and the actual product purchased shall prevail. Users can obtain the latest manual from [support.sungrowpower.com](http://support.sungrowpower.com) or sales channels.



# Contents

---

|   |          |
|---|----------|
| All Rights Reserved .....                       | I        |
| About This Manual .....                         | II       |
| <b>1 Safe Instructions .....</b>                | <b>1</b> |
| 1.1 Symbols .....                               | 1        |
| 1.2 Packaging, Shipping and Storage .....       | 2        |
| 1.3 Operations .....                            | 3        |
| 1.4 Maintenance and Replacement .....           | 4        |
| <b>2 Product Introduction .....</b>             | <b>5</b> |
| 2.1 Introduction .....                          | 5        |
| 2.2 Production Introduction .....               | 6        |
| 2.2.1 Appearance and Dimensions .....           | 6        |
| 2.2.2 Internal Structure .....                  | 6        |
| 2.2.3 External Port .....                       | 7        |
| 2.2.4 LED Indicator Signals .....               | 8        |
| 2.3 Unpacking and Storage .....                 | 8        |
| 2.3.1 Unpacking and Inspection .....            | 8        |
| 2.3.2 Packing list .....                        | 9        |
| 2.3.3 Storage .....                             | 10       |
| 2.4 Installation .....                          | 11       |
| 2.4.1 Safety .....                              | 11       |
| 2.4.2 Installation Tools .....                  | 12       |
| 2.4.3 Installation Clearance .....              | 13       |
| 2.4.4 Pre-installation Preparation .....        | 14       |
| 2.4.4.1 RCD Requirements .....                  | 14       |
| 2.4.4.2 AC Input Cable .....                    | 15       |
| 2.4.4.3 OT terminal .....                       | 15       |
| 2.4.4.4 Ethernet Cable Requirements .....       | 15       |
| 2.4.4.5 SIM Card Requirements .....             | 15       |
| 2.4.5 Wall-Mounted Installation .....           | 16       |
| 2.4.5.1 Install the Wall-Mounting Bracket ..... | 16       |
| 2.4.5.2 Install Charger Brackets .....          | 16       |

|          |   |    |
|----------|---|----|
| 2.4.5.3  | Install the Handles .....                                       | 16 |
| 2.4.5.4  | Charger Installation.....                                       | 17 |
| 2.4.5.5  | Remove the Handles .....  | 17 |
| 2.4.5.6  | Secure the Charger .....  | 18 |
| 2.4.5.7  | Install the Charging Connector Socket.....                      | 18 |
| 2.4.5.8  | Connect the Cable Connection Terminal .....                     | 20 |
| 2.4.5.9  | Ethernet Cable Connection.....                                  | 23 |
| 2.4.5.10 | SIM Card Installation.....                                      | 24 |
| 2.4.6    | Pole-mounted Installation (Optional).....                       | 24 |
| 2.4.6.1  | Pole Components .....   | 25 |
| 2.4.6.2  | Recommended Construction Scheme for Charger<br>Foundation ..... | 26 |
| 2.4.6.3  | Remove the Cover Plate .....                                    | 26 |
| 2.4.6.4  | Install the Mounting Pole .....                                 | 27 |
| 2.4.6.5  | Install the Handles .....                                       | 28 |
| 2.4.6.6  | Charger Installation.....                                       | 28 |
| 2.4.6.7  | Detach the Handles .....  | 29 |
| 2.4.6.8  | Install the Charger Connector Socket .....                      | 29 |
| 2.4.6.9  | Connect the AC Cable .....                                      | 30 |
| 2.4.6.10 | Install the Cover Plate .....                                   | 31 |
| 2.4.6.11 | Charger Connector Installation.....                             | 31 |
| 2.4.7    | Movable Charger Installation (Optional) .....                   | 32 |
| 3        | Interface Function Description .....                            | 35 |
| 3.1      | Page Introduction .....   | 35 |
| 3.1.1    | System Check .....  | 35 |
| 3.1.2    | Start Page .....  | 35 |
| 3.1.3    | Other Pages .....   | 36 |
| 3.1.3.1  | <b>Unavailable</b> .....  | 37 |
| 3.1.3.2  | Emergency Stop.....   | 38 |
| 3.1.3.3  | Firmware Update.....  | 40 |
| 3.1.3.4  | Offline.....  | 41 |
| 3.1.3.5  | Abnormal .....  | 41 |
| 3.1.3.6  | Language Settings.....  | 42 |
| 3.2      | Charging .....  | 43 |
| 3.2.1    | Plug the Charging Connector .....                               | 43 |
| 3.2.2    | Charging Method .....   | 44 |
| 3.2.2.1  | Charging via RFID Card .....                                    | 44 |

|   |           |
|---|-----------|
| 3.2.2.2 Plug&Play .....                       | 49        |
| <b>4 Operation and Maintenance Mode .....</b> | <b>51</b> |
| 4.1 Login and Logout.....                     | 51        |
| 4.1.1 Login.....                              | 51        |
| 4.1.2 Logout.....                             | 52        |
| 4.2 Function Description .....                | 52        |
| 4.2.1 CCU Info .....                          | 52        |
| 4.2.2 Version.....                            | 56        |
| 4.2.3 Config_1 .....                          | 57        |
| <b>5 iEnergyCharge App .....</b>              | <b>61</b> |
| 5.1 Download and Installation .....           | 61        |
| 5.2 Sign-up and Log in.....                   | 61        |
| 5.3 Add a Charger .....                       | 62        |
| <b>6 Faults and Troubleshooting .....</b>     | <b>63</b> |
| 6.1 TCU .....                                 | 63        |
| 6.2 CCU .....                                 | 67        |
| 6.3 LLC .....                                 | 69        |
| 6.4 PFC.....                                  | 73        |
| 6.5 Charging Stop Code .....                  | 77        |
| <b>7 System Maintenance .....</b>             | <b>84</b> |
| 7.1 Inspection Instructions .....             | 84        |
| 7.2 Routine Inspection.....                   | 84        |
| <b>8 Appendix .....</b>                       | <b>87</b> |
| 8.1 System Parameters.....                    | 87        |
| 8.2 Quality Assurance .....                   | 90        |
| 8.3 Contact Information .....                 | 91        |



# 1 Safe Instructions

## 1.1 Symbols

This manual contains important safety instructions, which are highlighted with the following symbols, to ensure personal and property safety during usage, or to help optimize the product performance efficiently.

### DANGER

Indicates high-risk potential hazards that, if not avoided, may lead to death or serious injury.

### WARNING

Indicates potential moderate-risk potential hazards that, if not avoided, may lead to death or serious injury.

### CAUTION

Indicates potential low-risk potential hazards that, if not avoided, may lead to minor or moderate injury.

### NOTICE





Indicates potential risks that, if not avoided, may lead to device malfunction or financial losses.



“NOTE” indicates additional information, emphasized content, or tips that may help you solve problems or save time.

Please pay attention to the danger warning signs on the machine body at all times. The signs include:

table 1-1 Symbols description

| Symbols   | Description  |
|---|--|
|  | Operation by qualified personnel only.   |
|  | The temperature here is higher than the acceptable range for the human body. Do not touch it without protection.                             |
|  | Please read the manual before any operation.   |
|  | Hazardous voltage still exists after the device stops. Do not conduct any operation on the device immediately. Wait for at least 10 minutes. |

## 1.2 Packaging, Shipping and Storage

### Packaging

#### NOTICE

The charger is wrapped tightly with wire drawing film and protected by foam blocks. It is packed in cardboard and underpinned by a wooden bottom base.

### Shipping

#### NOTICE

During shipping, the charger shall be packed firmly and intact with cardboard and wooden bottom support, the loading and unloading directions are clearly marked, and the charger shall not be stored and shipped upside down.

During transport, make sure that the equipment is firmly fixed in order to avoid violent shaking and bumps that damage the packaging and its content.

After arrival of goods, check for transport damage and, if any, contact the shipping company or SUNGROW.

Check if the content inside the package matches the delivery list.

#### DANGER

Non-professional personnel shall not disassemble the components.

## Storage

### NOTICE

The device shall be stored in a dry, clean, and well-ventilated place, free from harmful gases.

Storage temperature:  $-40^{\circ}\text{C}\sim+70^{\circ}\text{C}$

Ambient temperature at startup:  $-35^{\circ}\text{C}\sim+55^{\circ}\text{C}$

Ambient temperature at full power:  $-25^{\circ}\text{C}\sim+50^{\circ}\text{C}$

Relative humidity: 5%~95% non-condensing

Do not store it near corrosive articles.

## 1.3 Operations

### DANGER

High voltages are present during operation and could cause electrical shock, resulting in death, serious personal injury, or serious property damage. Follow the safety instructions listed in this manual and other relevant documentation.

When the device is working, the temperature around the heat dissipation air outlet is high and there is a risk of burns. Please do not touch it.

When operating the device, local regulations and specifications shall be observed.

No extension cables shall be used when connecting an electric vehicle to an electric vehicle power supply device.

Only connect electric vehicles and their charging equipment. Do not connect any other loads (electric tools, etc.).

After charging, please put the charging connector back into the connector socket to prevent unnecessary exposure to contamination or moisture.

Do not bend, squeeze or roll the charging connector to avoid mechanical damage.

Do not expose the surfaces of the charger to heat, dirt, or water.

It is strictly prohibited to use the charger when the charging connector or the charging cable is defective, appears cracked, frayed, broken, or otherwise damaged. If any anomaly is found, please, refer to the seller or SUNGROW

If there is any abnormality during use, please press the emergency stop button immediately to cut off the power supply.

In case of a thunderstorm, please charge carefully.

Children shall not approach or use the charger during the charging process to avoid injury.

During a thunderstorm, please, charge carefully and be aware of the potential risks.

When charging an electric vehicle with a charger, read carefully the relevant tips and instructions of the vehicle.

## 1.4 Maintenance and Replacement

### DANGER

**High voltages are present during operation and could cause electrical shocks, resulting in death, serious personal injury, or serious property damage. Before any maintenance work, the device must be powered off and operated in strict accordance with the safety precautions listed in this manual and other relevant documentation.**

**Maintain the equipment, only once you have familiarized yourself with the contents of this manual and with suitable tools and test equipment.**

**Before performing maintenance work, power down the device and wait at least 10 minutes before operating the device.**

**During maintenance, avoid the presence of unrelated persons at the maintenance site, and place temporary to warn signs or barriers to isolate them.**

**Do not power the device until you have confirmed that any faults affecting the safe performance of the device have been removed.**

**Observe the ESD protection specifications during maintenance.**

**Keep the charging connector clean and dry, and wipe it with a clean, dry cloth if it is dirty. Do not touch the charging connector's pins with your hands while it is on. It is necessary to regularly check whether there is damage to the connector, and check whether the enclosure and surrounding components have visible signs of damage. (Visual inspection)**



## 2 Product Introduction

### 2.1 Introduction

The 30kW DC charger (hereinafter “Charger”) is used for DC charging of electric vehicles (EVs) and can be wall-mounted, pole-mounted, or cart-mounted, with the following advantages:

#### **Technology leadership**

Adopting the world's leading power supply technology and design concept, the charger is designed to provide safe, reliable, and controllable DC power for electric vehicles.

#### **Enhanced features**

It is featured active power correction, high efficiency, high power density, high reliability, ultra-low standby power consumption, intelligent control, and excellent human-computer interaction experience.

#### **Future-proofed**

With ultra-wide constant power output voltage, it can support all electric vehicles in the market and meets their charging needs.

## 2.2 Production Introduction

### 2.2.1 Appearance and Dimensions

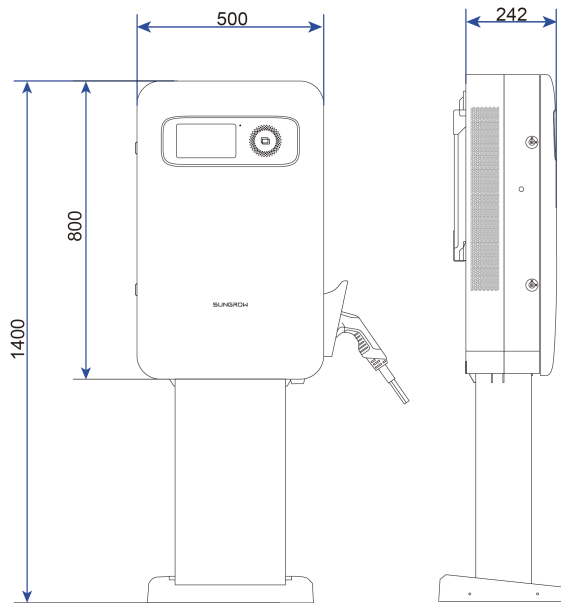

figure 2-1 Product Dimensions (in mm)

### 2.2.2 Internal Structure

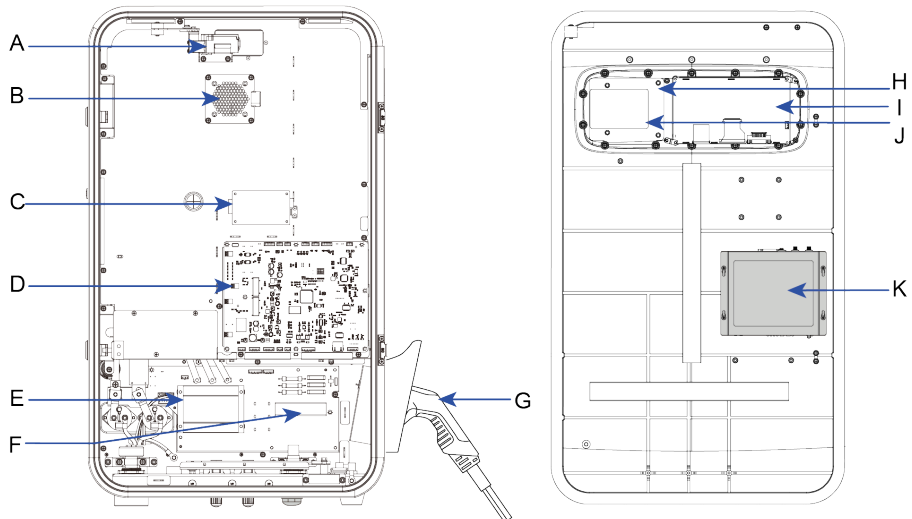

figure 2-2 Diagram of the Internal Structure

table 2-1 Internal Structure Description

| No. | Name           |
|-----|----------------|
| A   | Door sensor    |
| B   | Axial flow fan |

| No. | Name                                |
|-----|-------------------------------------|
| C   | Insulation Monitor                  |
| D   | CCU(Charge Control Unit) module     |
| E   | DC Meter                            |
| F   | AC input connection terminal        |
| G   | Charging connector                  |
| H   | Lamp panel                          |
| I   | Display                             |
| J   | Card Reader                         |
| K   | TCU(Tariff and Control Unit) module |

### 2.2.3 External Port

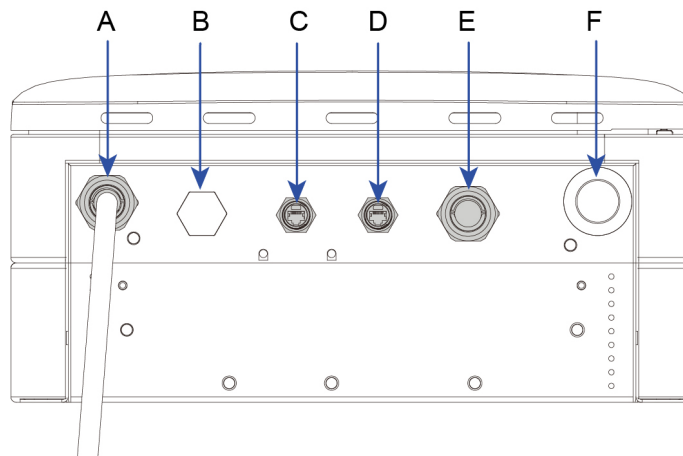

figure 2-3 Diagram of Bottom Terminals

table 2-2 Description of Bottom Terminals

| No. | Name                    |
|-----|-------------------------|
| A   | DC charger cable outlet |
| B   | Air outlet              |
| C   | RSVD port               |
| D   | LAN port                |
| E   | AC cable inlet          |
| F   | 4G & WiFi antenna       |

## 2.2.4 LED Indicator Signals

table 2-3 Indicator status

| The indicator color | Indicator Effect  | Re-<br>marks | Meaning   |
|---------------------|---|--------------|---|
| Blue indicator      | Blue indicator is constantly on                               | Normal       | Fully charged ( include the charging connector is connected to but not charge the vehicle ) |
|                     | Blue indicator flashes, on for 1s and off for 1s; circulating | Normal       | Charging  |
| Red indicator       | Red indicator is constantly on                                | Abnormal     | Fault   |
| Green indicator     | Green indicator is constantly on                              | Normal       | Standby   |

## 2.3 Unpacking and Storage

### 2.3.1 Unpacking and Inspection

Each device is thoroughly tested and carefully inspected before delivery. Nonetheless, damage may still occur during shipping. For this reason, please conduct a thorough inspection of the device.

- Check the packaging case for any visible damage. If damage is confirmed please take pictures before unpacking the product.
- Check to make sure that the scope of delivery matches the packing list.
- Check the inner contents for damage after unpacking.

Contact SUNGROW or the transport company in case of any damage or mismatches and provide photos to facilitate services.

Do not dispose of the original packing case. It is recommended to store the device in original packing case when the device is decommissioned.

#### NOTICE

**After receiving the product, check whether the appearance and structural parts of the device are damaged, and check whether the packing list is consistent with the actual ordered product.**

**If there are problems with the above inspection items, do not install the device and contact SUNGROW as soon as possible.**

**If cutters is uses for unpacking, be careful not to damage the charger.**

### 2.3.2 Packing list



A

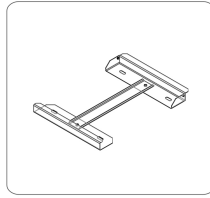

B

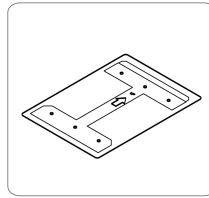

C

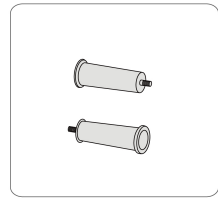

D

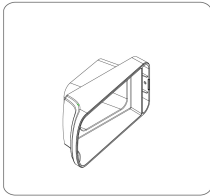

E

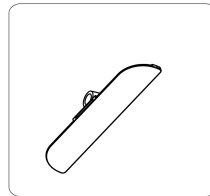

F

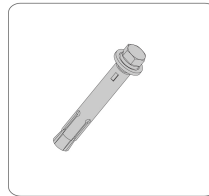

G



H

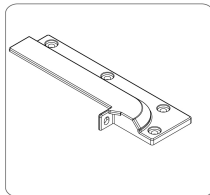

I

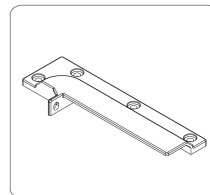

J

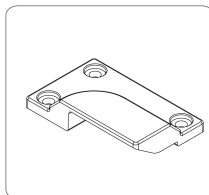

K

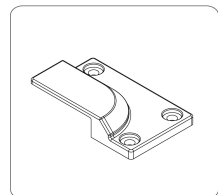

L



M

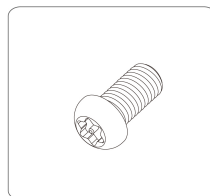

N

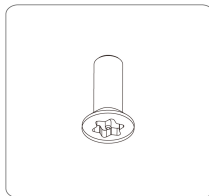

O

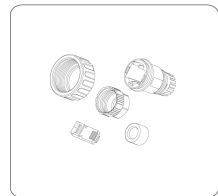

P

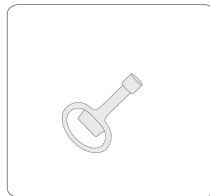

Q

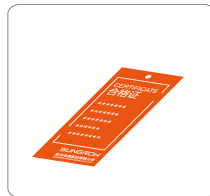

R

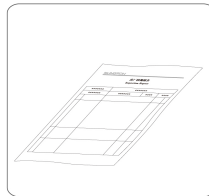

S

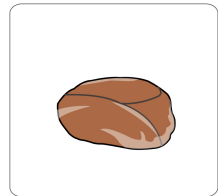

T

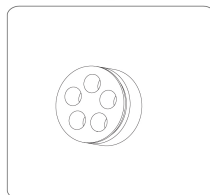

U

figure 2-4 Packing list

table 2-4 Packing list

| No. | Name  | Unit | No. |
|-----|---|------|-----|
| A   | Integrated single-connector DC charger IDC30E                         | PCS  | 1   |
| B   | IDC30E wall-mounted weld assembly                                     | PCS  | 1   |
| C   | Positioning plate   | PCS  | 1   |
| D   | Handrail_M12  | PCS  | 2   |
| E   | IDC30E socket-outlet trim   | PCS  | 1   |
| F   | IDC30E socket-outlet trim B   | PCS  | 1   |
| G   | Expansion bolt  | PCS  | 6   |
| H   | M1 card   | PCS  | 2   |
| I   | Wall-mounted components-upper left                                    | PCS  | 1   |
| J   | Wall-mounted components-upper right                                   | PCS  | 1   |
| K   | Wall-mounted components-lower left                                    | PCS  | 1   |
| L   | Wall-mounted components-lower right                                   | PCS  | 1   |
| M   | Montmorillonite desiccant   | PCS  | 1   |
| N   | Hexalobular socket pan head tamper proof screws M5X12, SUS304         | PCS  | 20  |
| O   | Hexalobular socket countersunk head tamper proof screws M4X12, SUS304 | PCS  | 1   |
| P   | Modular RJ45 plug   | PCS  | 2   |
| Q   | Keys  | PCS  | 2   |
| R   | Certificate of Conformity   | PCS  | 1   |
| S   | Test report   | PCS  | 1   |
| T   | Fireproof mud   | PCS  | 1   |
| U   | Five-hole waterproof ring   | PCS  | 1   |

### 2.3.3 Storage

Proper storage is required if the charger is not to be installed immediately.

- Store the charger in the original packing case with the desiccant inside.
- The storage temperature must be always between -40°C and +70°C, and the storage relative humidity must be always between 5% and 95%, non-condensing.
- In case of stacking storage, the number of stacking layers should never exceed the limit marked on the outer side of the packing case.
- The packing case should be upright.

- If the charger needs to be transported again, pack it tightly before loading and transporting it.
- Do not store the charger in places with items that may affect or damage the charger.
- Store the charger in a clean and dry place to prevent dust and water vapor exposure.
- Do not store the charger in places with corrosive substances or susceptible to rodents and insects.
- Carry out periodic inspections. If any insect or rodent bites are found, replace the packaging materials in due time.
- If the charger has been stored for more than a year, inspection and testing by professionals are required before it can be put into operation.

#### NOTICE

**Please store the charger according to the storage requirements. Product damage caused by failure to meet the storage requirements is not covered by the warranty.**

## 2.4 Installation

#### WARNING

**Respect all local standards and requirements during mechanical installation.**

### 2.4.1 Safety

#### DANGER

**Make sure there is no electrical connection before installation.  
In order to avoid electric shock or other injury, make sure that holes will not be drilled through and interrupting any electricity or plumbing installations.**

#### WARNING

**Poor installation environment will affect system performance!  
Install the charger in a well-ventilated place.  
Ensure that the heat dissipation system or vents are not blocked.  
Do not install the charger in an environment with smoke, flammable and explosive objects.**

#### CAUTION

**Improper handling may cause personal injury!  
When moving the charger, be aware of its weight and keep the balance to prevent it from tilting or falling.  
Wear proper protective equipment before performing operations on the charger.**

## 2.4.2 Installation Tools

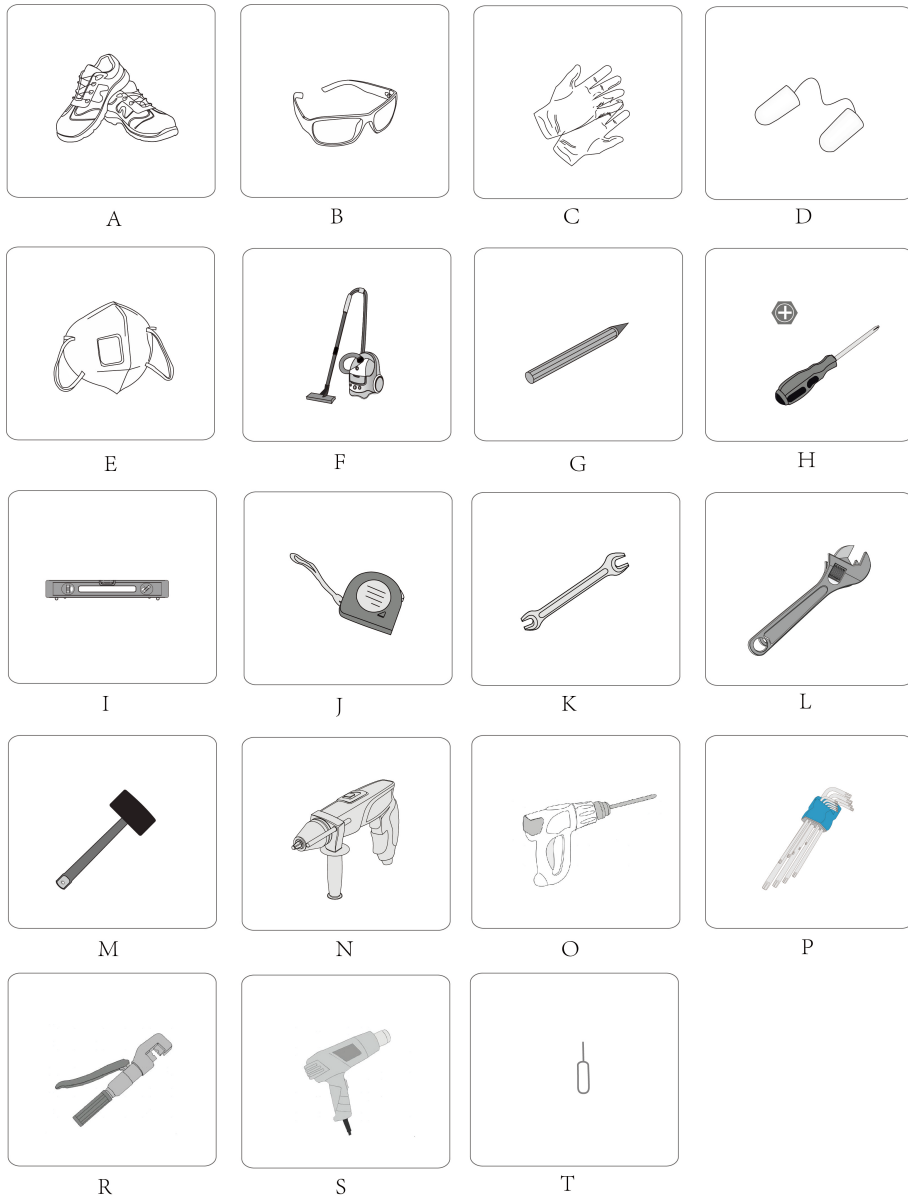

figure 2-5 Tools

table 2-5 Tools

| No. | Name              |
|-----|-------------------|
| A   | Working shoes     |
| B   | Goggles           |
| C   | Insulating gloves |
| D   | Earplugs          |



| No. | Name                             |
|-----|----------------------------------|
| E   | Dust proof mask                  |
| F   | Vacuum cleaner                   |
| G   | Marker                           |
| H   | Phillips screwdriver             |
| I   | Level                            |
| J   | Measuring tape                   |
| K   | No.13 wrench, No.19 wrench       |
| L   | French wrench                    |
| M   | Rubber hammer                    |
| N   | Electric drill                   |
| O   | Cable drilling tool: Ø12/Ø18     |
| P   | Pan head tamper proof wrench set |
| R   | Hydraulic clamp                  |
| S   | Hot air blower                   |
| T   | SIM card ejector pin             |

### 2.4.3 Installation Clearance

Reserve ample clearance (see the following figure for details) on all sides of the charger to ensure well heat dissipation and convenient operation and maintenance.

When multiple chargers are to be installed in the chosen location, it is recommended to consider the width of the parking space.



Top :200mm Bottom:500mm Front:300mm Left and right sides:1000mm  
Clearance:2500mm

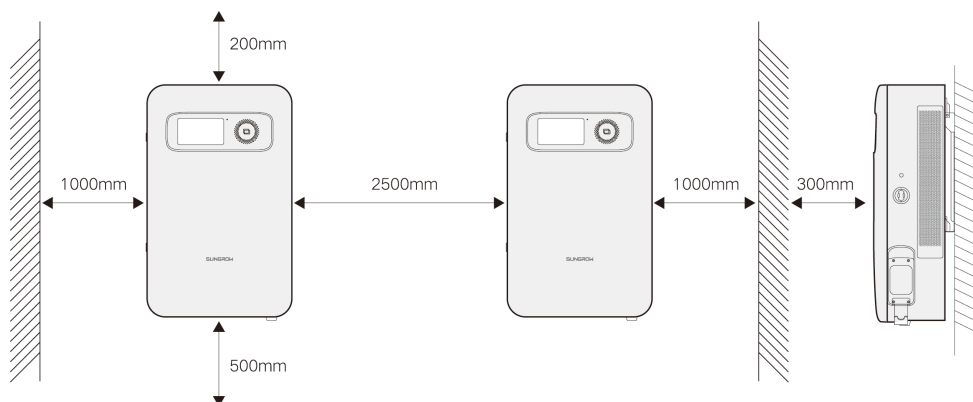

figure 2-6 Min. recommended installation clearance

**⚠ DANGER**

**Do not block the air inlet and outlet of the charger, charger damage may occur if otherwise.**

## 2.4.4 Pre-installation Preparation

### 2.4.4.1 RCD Requirements

A residual current device (RCD) should be set between the charger and the grid. Please use an RCBO or an RCCB+MCB assembly. The parameter requirements are listed as follows:

table 2-6 Requirements for RCD Parameters

| Parameters                                  | Value      |
|---|------------|
| Number of poles                             | 4P         |
| Type of pole                                | 3P+N /4P   |
| Thermomagnetic release characteristic       | C          |
| Rated breaking capacity I <sub>cn</sub>     | 6 kA       |
| Rated current I <sub>n</sub>                | 63         |
| Rated voltage U <sub>e</sub>                | 400V AC    |
| Rated frequency                             | 50 / 60 Hz |
| Residual current type                       | A          |
| Type(wave form of the earth leakage sensed) | S          |
| Rated residual operating current            | 100 mA     |
| Short-time delayed tripping                 | Yes        |
| Surge current resistance (wave 8/20)        | 3000 A     |

### 2.4.4.2 AC Input Cable

The five-core copper-conductor cable is recommended if the AC-side transmission distance is less than 400m.

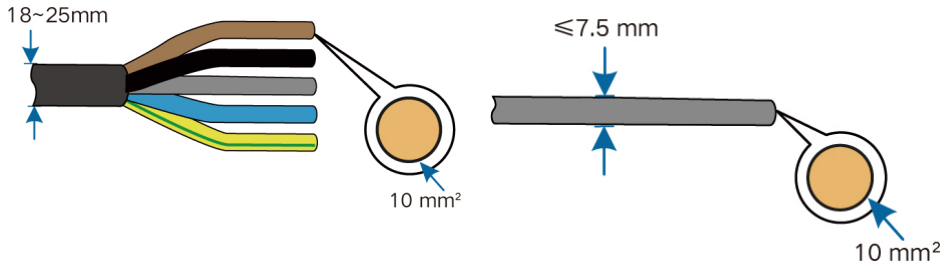

Outdoor five-core copper wire cable

Outdoor single-core copper wire cable

The cable colors in figures in this manual are for reference only. Please select cables according to local cable standards.

table 2-7 AC Cable Requirements

| Cable                                 | Cable Diameter (mm) | Conductor Cross-sectional Area(mm <sup>2</sup> ) |
|---------------------------------------|---------------------|--|
| Outdoor five-core copper wire cable   | 18-25               | 10   |
| Outdoor single-core copper wire cable | ≤7.5                | 10   |

### 2.4.4.3 OT terminal

To ensure the cable is securely connected to the wiring terminal, it is needed to crimp the corresponding terminal on the cable after leading the cable through the AC cable inlet. Poor contact may lead to overheating and even safety incidents.

OT terminals (not included in the delivery scope) are required for fixing AC cables to the terminal block. Purchase the OT terminals according to the following requirements.

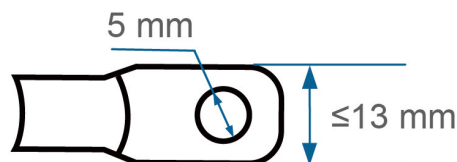

### 2.4.4.4 Ethernet Cable Requirements

Please use the 8-core Cat5e or Cat6 Ethernet cable.

### 2.4.4.5 SIM Card Requirements

Please use a SIM card, with at least 150 M of data available each month.

## 2.4.5 Wall-Mounted Installation



To close or open the door on site, press the front door panel firmly and then turn the key.

### 2.4.5.1 Install the Wall-Mounting Bracket

**Step 1** Place the positioning plate horizontally on the wall surface, and use a marker to mark the corresponding hole position;

**Step 2** Use an electric drilling tool to drill 12 mm diameter holes at the marked position with a hole depth of 70mm;

**Step 3** Put the expansion pipe with specification of M8\*60mm into the hole;

**Step 4** Use expansion bolts to fix the bracket on the wall and tighten it with a French wrench;

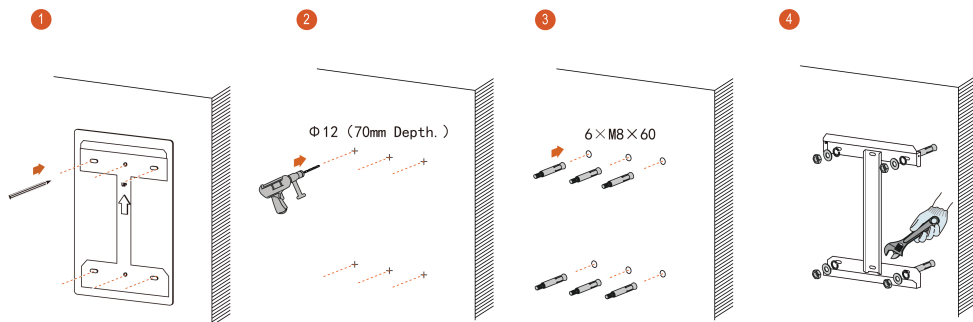

figure 2-7 Steps to drill holes

-- End

### 2.4.5.2 Install Charger Brackets

**Step 1** Place the charger back-up on a foam or soft cloth to prevent damage to its casing;

**Step 2** Attach the upper and lower brackets (4 in total) on the back of the charger with 14\*M5\*12 hexalobular socket pan head tamper proof screws;

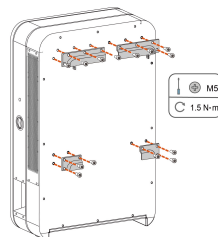

figure 2-8 Charger brackets installation

-- End

### 2.4.5.3 Install the Handles

**Step 1** Place the charger flat on the ground and keep it steady;

**Step 2** Remove the keyhole plug on both sides of the charger to expose the installation holes of the handles;

**Step 3** Align the handles with the handles' installation hole and tighten them clockwise to secure them to the charger.

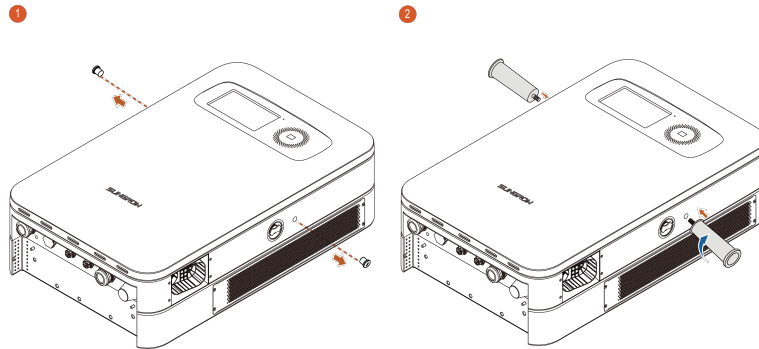

figure 2-9 Handrail installation

-- End

#### 2.4.5.4 Charger Installation

**Step 1** Hold each handle with both hands and put the charger gently close to the wall bracket;

**Step 2** Align the bracket on the back of the charger with the position of the wall bracket and hang this accordingly from top to bottom.

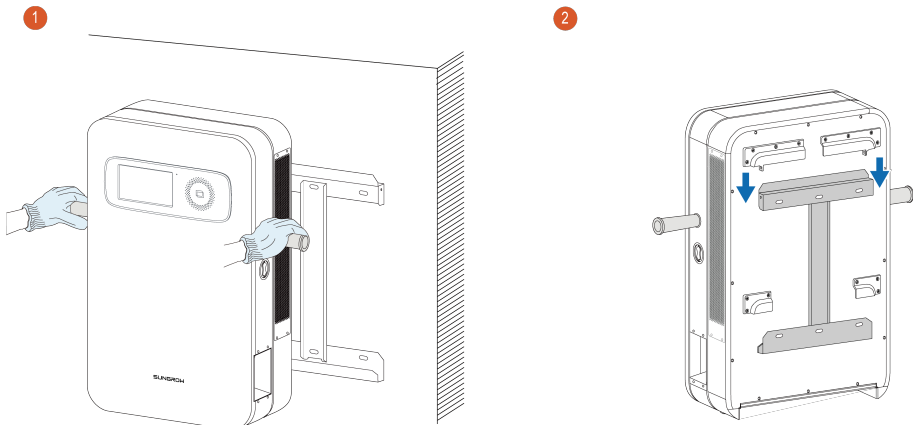

figure 2-10 Charger installation

-- End

#### 2.4.5.5 Remove the Handles

**Step 1** Turn the handles counterclockwise out of the charger to expose the handles' installation hole on the charger;

**Step 2** Align the keyhole plugs with the handles' installation holes and plug them back into the charger.

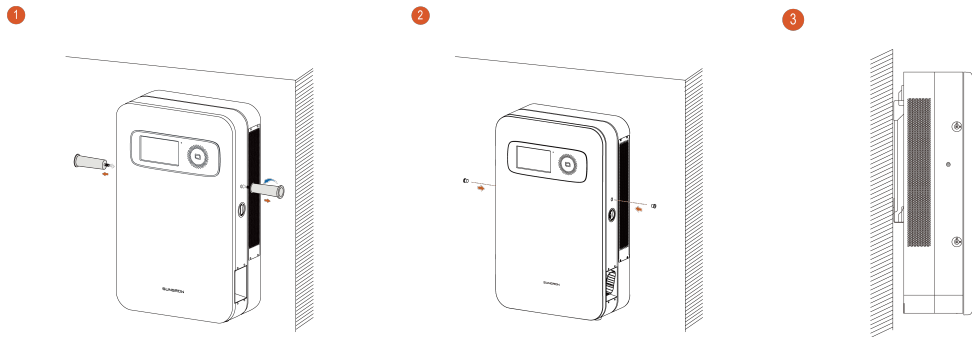
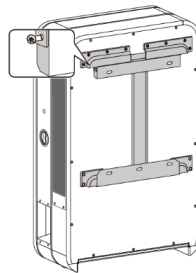

**figure 2-11** Installation of the keyhole plug

-- End

#### 2.4.5.6 Secure the Charger

**Step 1** Refer to the figure below, attach the charger to the wall bracket with M5\*12 hexalobular socket pan head tamper proof screws, recommended torque  $\leq 1.2\text{N}\cdot\text{m}$ .



**figure 2-12** Secure the charger

-- End

#### 2.4.5.7 Install the Charging Connector Socket

**Step 1** Place the connector socket horizontally at the mounting position;

**Step 2** Use M5\*12 hexalobular socket pan head tamper proof screws to attach the connector socket to the charger, recommended torque  $\leq 1.5\text{N}\cdot\text{m}$ ;

**Step 3** Put an orange plug on the bottom of the connector socket and secure it with M4\*12 hexalobular socket countersunk head screws;

**Step 4** Confirm that the connector socket is mounted firmly and then holster the charging connector into the charger's socket.

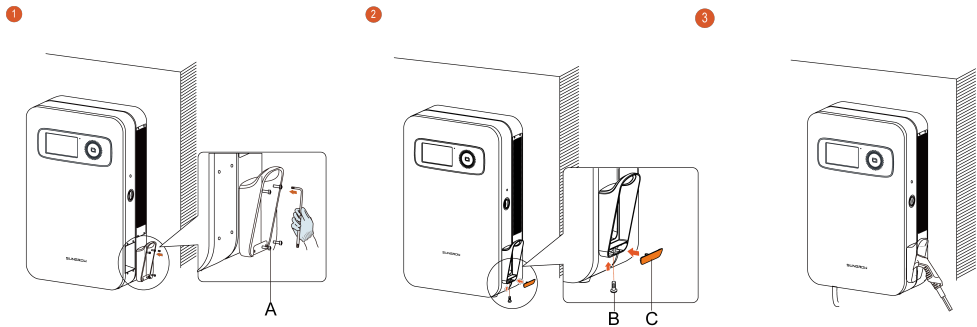

**figure 2-13** Installation of the connector socket

table 2-8 Accessories to install the connector socket

| No. | Name  | Quantity |
|-----|---|----------|
| A   | M5*12 hexalobular socket pan head tamper proof screws | 4        |
| B   | M4*12 hexalobular socket countersunk head screws      | 1        |
| C   | Orange plug   | 1        |



The hexagon socket screws mentioned in this manual are all fastened or removed by flower-shaped tamper proof wrench specified in ""figure 2-5 Tools""

-- End

### 2.4.5.8 Connect the Cable Connection Terminal

**Step 1** Remove the AC waterproof connector from the charger. Select the appropriate waterproof ring for the connector based on the AC cable type.

- 1 If the multi-core cable is adopted, use the single-hole waterproof ring that comes with the AC waterproof connector.

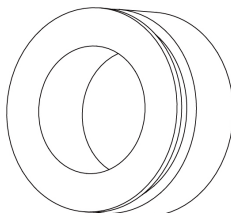

**figure 2-14** Single-hole Waterproof Ring

- 2 If the single-core cable is adopted, use the five-hole waterproof ring included in the packing list.

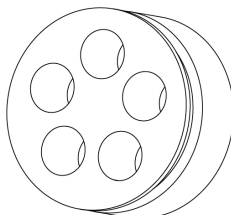

**figure 2-15** Five-hole Waterproof Ring

**Step 2** Lead the cable wires through the AC waterproof connector in the proper order one by one.

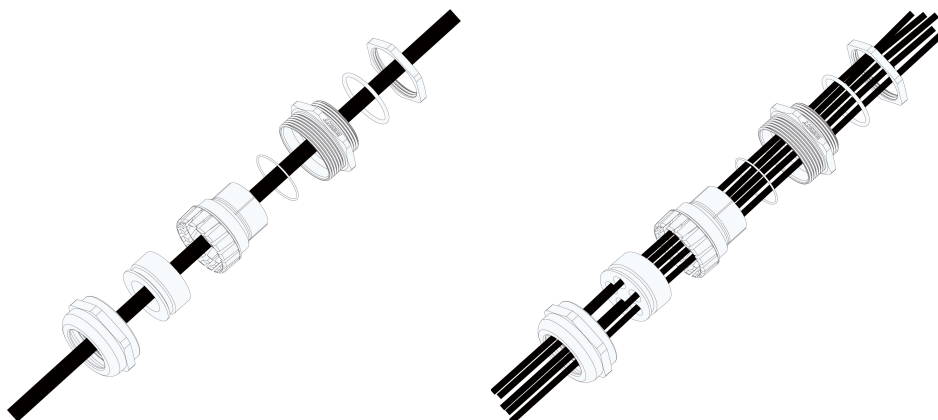

If the charger is mounted on a pole, you can use a bracket to secure the connector to prevent it from falling down to the bottom of the pole.



**Step 3** Strip the protection layer and insulation layer by specific length, as described in the figure below;

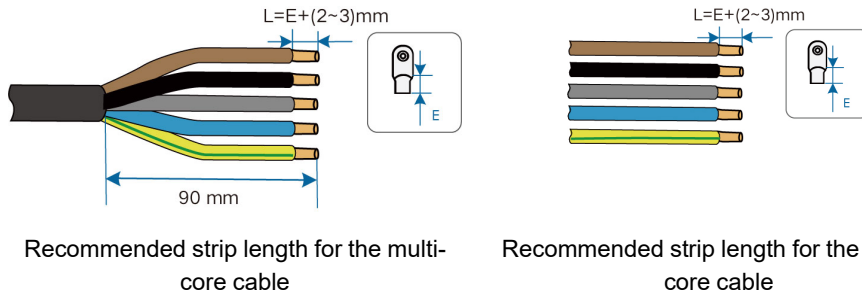

#### NOTICE

**Please strip the wire by the recommended strip length; otherwise, the sealing performance of the waterproof connector may get affected.**

**Step 4** Insert the copper core of the stripped end of the wire into the copper lug of OT terminal and press it with a terminal crimping machine;

**Step 5** Select a heat-shrink tubing that matches the diameter of the wire, insert it to the terminal crimping position, and then tighten the heat-shrink tubing with a hot air blower;

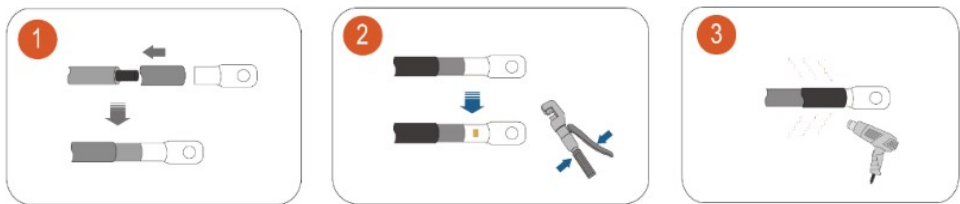
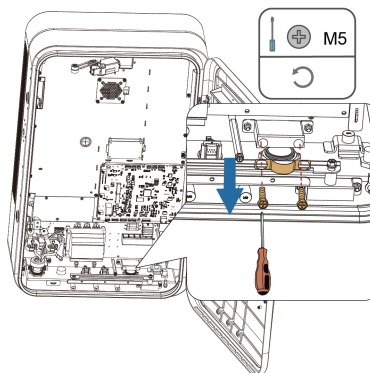
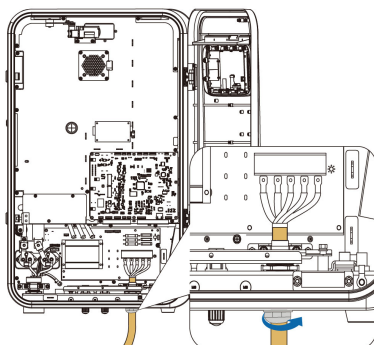

figure 2-16 Terminal crimping

**Step 6** Remove the cable clamp.



**Step 7** Lead the crimped AC cable into the AC cable inlet. Then, fit back the waterproof connector, and slightly tighten the swivel nut. Please make sure the insulation layer of the cable, where it is fastened by the waterproof connector, is intact.



**Step 8** Refer to the figure below, use M5 screws to attach the terminal to the specified position with a tightening torque of  $3 \pm 0.2 \text{ N}\cdot\text{m}$ .

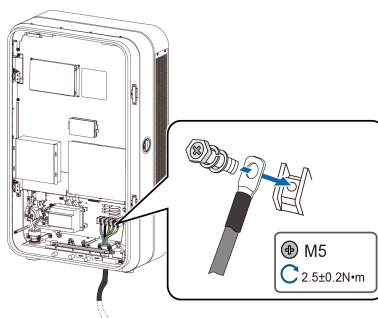
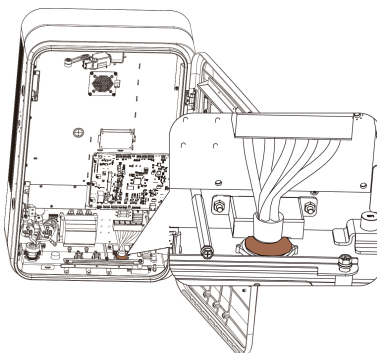

**figure 2-17** Connect the cable connection terminal



When transmission distance within 400m: 10mm<sup>2</sup> copper core cable is recommended.

**Step 9** Use an open-end wrench with an opening of over 40mm to tighten the swivel nut on the AC waterproof connector. Then, seal off the cable outlet of the waterproof connector with fire-proof mud.



**Step 10** Re-install the cable clamp.

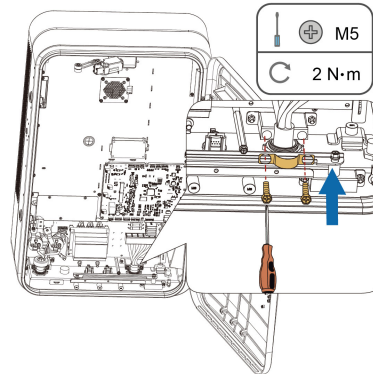

-- End

### 2.4.5.9 Ethernet Cable Connection

If an Ethernet cable is used for accessing IDC30E to the network, proceed with the following steps.

**Step 1** Unscrew the sealing nut from the communication connector, and remove the sealing rubber washer inside.

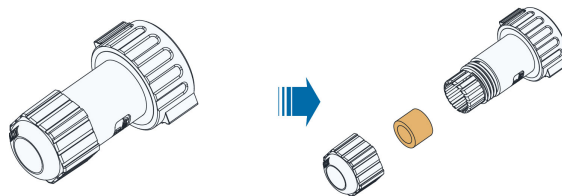

**Step 2** Push the cable through the parts in order, and strip it by 10-15mm.

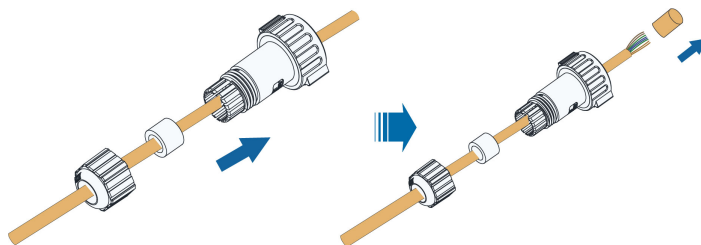

**Step 3** Crimp the RJ45 plug on the cable.

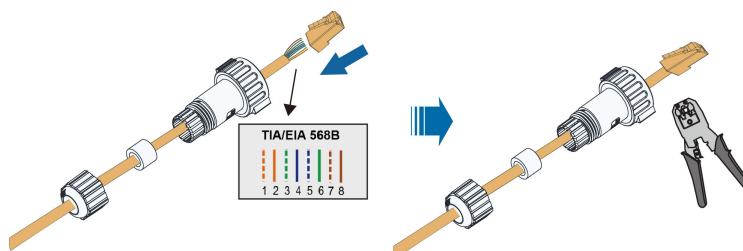

**Step 4** Fit back the rubber washer, and tighten the nut.

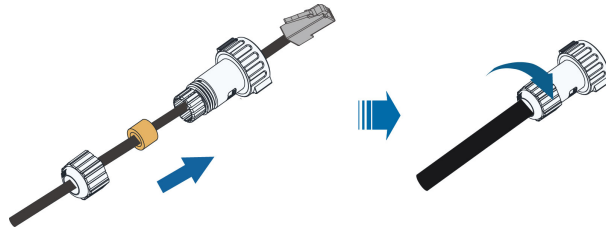

**Step 5** Remove the waterproof plug from the LAN port on the bottom of the charger. Insert the communication connector into the LAN port and make sure it "clicks" in place.

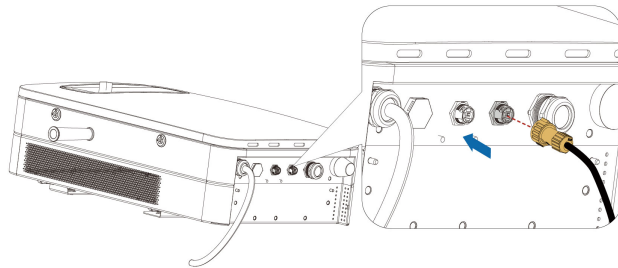

-- End

#### 2.4.5.10 SIM Card Installation

If a SIM card is used for accessing IDC30E to the network, proceed with the following steps.

**Step 1** Take out the SIM card tray from the TCU module using an ejector pin (needs to be prepared separately).

**Step 2** Put the SIM card in the tray, and push the tray back into the SIM card slot.

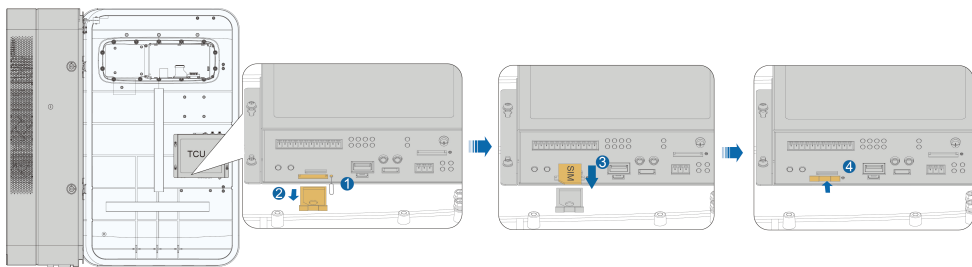

-- End

#### 2.4.6 Pole-mounted Installation (Optional)

**2.4.6.1 Pole Components**

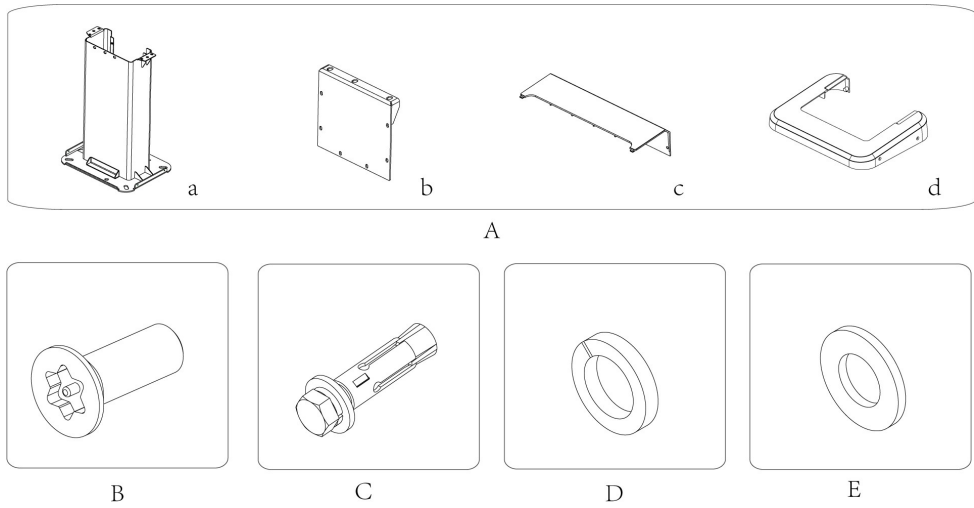

**figure 2-18** Pole Components

table 2-9 Description of pole components

| No. | Name   | Unit | Quantify |
|-----|--|------|----------|
| A   | a Pole weld assembly                               | pcs  | 1        |
|     | b Pole back cover                                  | pcs  | 1        |
|     | c Pole top cover                                   | pcs  | 1        |
|     | d Pole top cover                                   | pcs  | 1        |
| B   | Hexalobular socket cheese head tamper proof screws | pcs  | 10       |
| C   | Expansion bolt M12*110                             | pcs  | 10       |
| D   | Standard spring washer                             | pcs  | 10       |
| E   | Flat washer of Class A                             | pcs  | 6        |

### 2.4.6.2 Recommended Construction Scheme for Charger Foundation

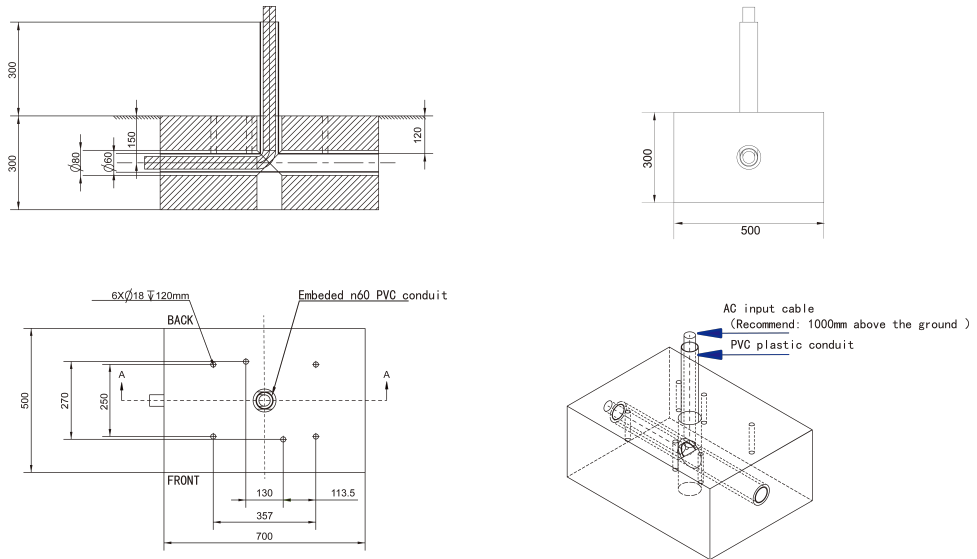

figure 2-19 Charger foundation diagram



The n60 PVC conduit is embedded in the foundation, and the AC input cable passes through the PVC plastic conduit for subsequent connection with the internal circuit of the charger.

It is recommended that the AC input cable be 1000mm above the ground.

### 2.4.6.3 Remove the Cover Plate

**Step 1** Remove the set screws of the base cover plate of the charger;

**Step 2** Pull the base cover plates out;

**Step 3** Remove the set screws of the cover plate on the back of the charger and remove the back cover.

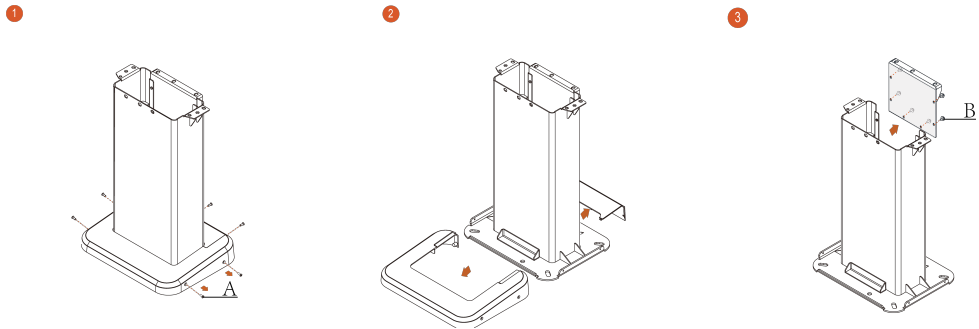

**figure 2-20** Remove the back-cover plate

table 2-10 Accessories to remove the back-cover

| No. | Name  | Quantity |
|-----|---|----------|
| A   | M5*14 hexalobular socket countersunk head screws      | 6        |
| B   | M5*12 hexalobular socket pan head tamper proof screws | 6        |

-- End

#### 2.4.6.4 Install the Mounting Pole

**Step 1** Place the pole on the foundation and mark the drilling hole locations;

**Step 2** Use cable drilling tool to drill holes in the locations you marked with a hole diameter of 18mm and depth of 120mm;

**Step 3** Insert the expansion bushing M12\*110 into the hole;

**Step 4** Use No.19 wrench to attach the pole to the foundation.

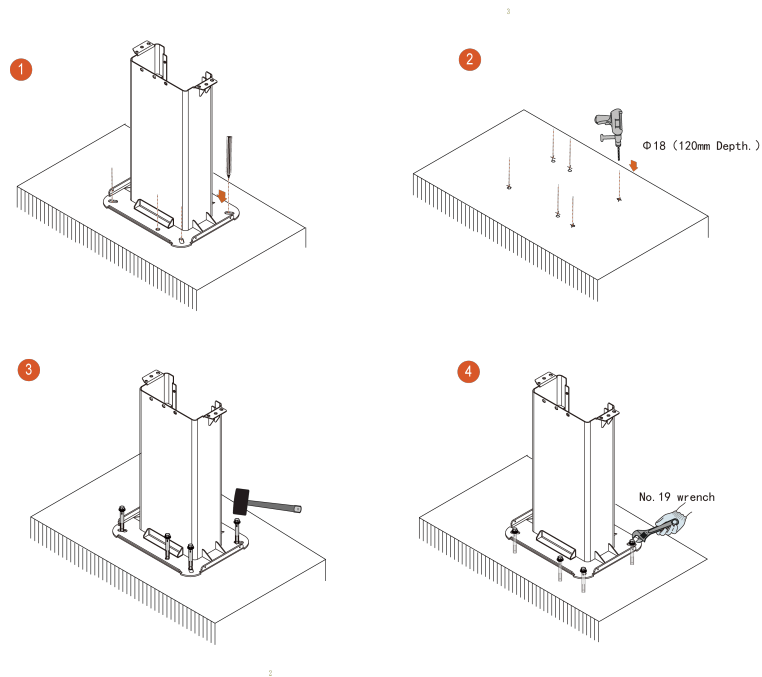

**figure 2-21** Pole installation

-- End

#### 2.4.6.5 Install the Handles

For detailed installation information, please refer to "[2.4.5 Wall-Mounted Installation](#)".

#### 2.4.6.6 Charger Installation

**Step 1** Hold the handles with both hands and lift the charger to the upper end of the pole;

**Step 2** Align the charger with the positioning pin of the pole;



**Step 3** Use M8\*16 hexalobular socket pan head tamper proof screws to lock the charger with the pole and confirm that they are correct before use.

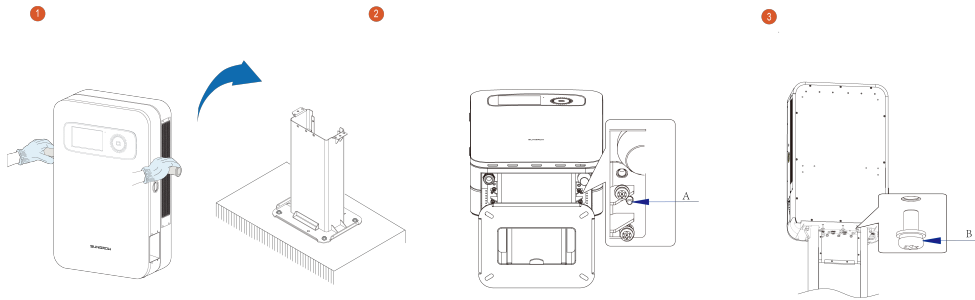

figure 2-22 Charger installation

table 2-11 Accessories to install the charger

| No. | Name  | Quantity |
|-----|---|----------|
| A   | Positioning pin                                       | 2        |
|     | M8*16 hexalobular socket pan head tamper proof screws | 10       |
| B   | Spring  | 10       |
|     | Flat washer   | 10       |

-- End

#### 2.4.6.7 Detach the Handles

For detailed installation information, please refer to "2.4.5 Wall-Mounted Installation" Remove the handles.

#### 2.4.6.8 Install the Charger Connector Socket

**Step 1** Place the connector socket horizontally at the mounting position;

**Step 2** Use M5\*12 hexalobular socket pan head tamper proof screws to attach the connector socket to the charger, recommended torque  $\leq 1.5\text{N}\cdot\text{m}$ ;

**Step 3** Put an orange plug on the bottom of the connector socket;

**Step 4** Secure the orange plug with M4\*12 hexalobular socket pan head screws.

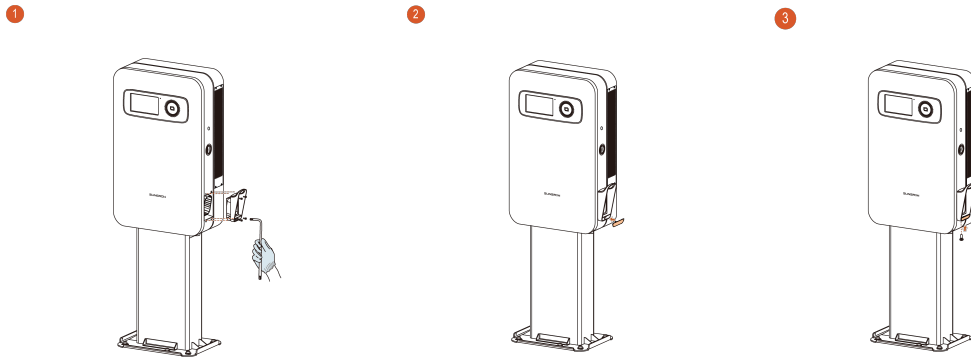

**figure 2-23** Install the connector socket

-- End

#### 2.4.6.9 Connect the AC Cable

**Step 1** Open the charger cabinet door;

**Step 2** Lead the AC cable through the PVC plastic conduit embedded in the foundation and pole, and then connect to the charger.

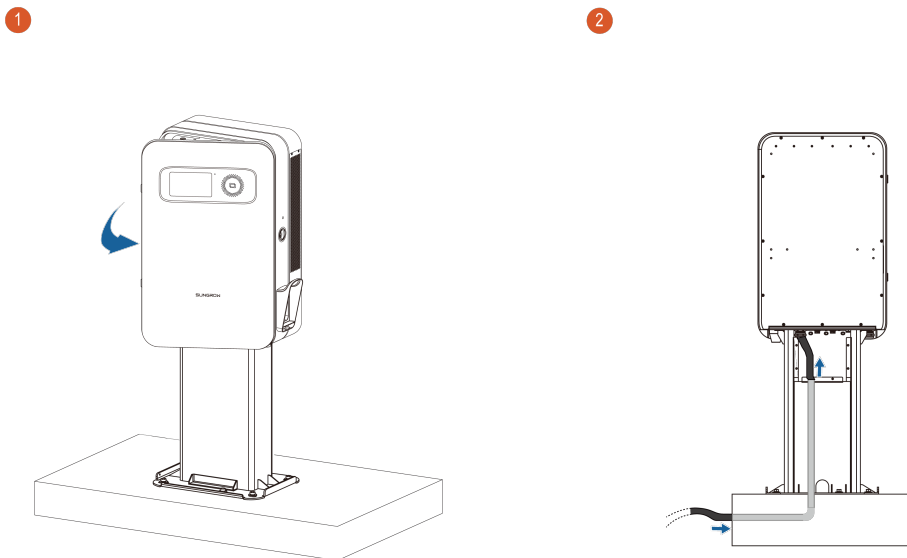

**figure 2-24** AC Cable connection

**Step 3** For detailed information of AC terminal connection, please refer to "[2.4.5.8 Connect the Cable Connection Terminal](#)"

**Step 4** For detailed information of network connection, please refer to "[2.4.5.10 SIM Card Installation](#)" and "[2.4.5.10 SIM Card Installation](#)"

-- End

### 2.4.6.10 Install the Cover Plate

**Step 1** Connect the back-cover plate of the charger and secure it with M5\*12 hexalobular socket countersunk head screws;

**Step 2** Close the base-cover plate and attach it to the pole with M5\*14 hexalobular socket pan head tamper proof screws.

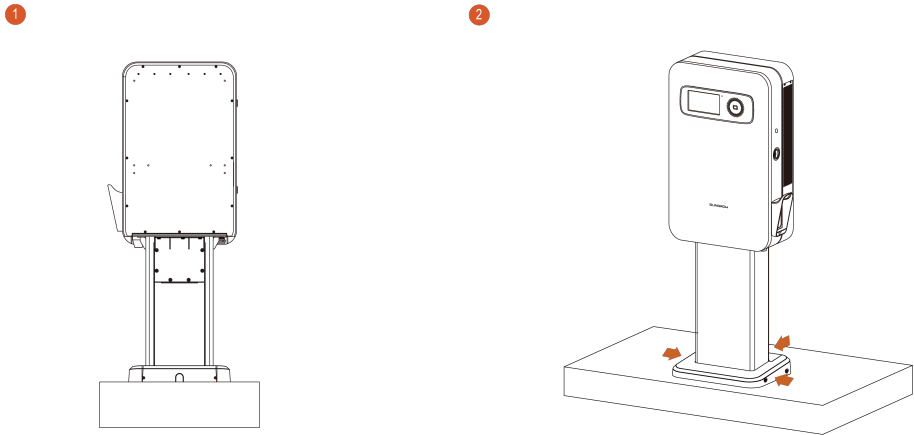
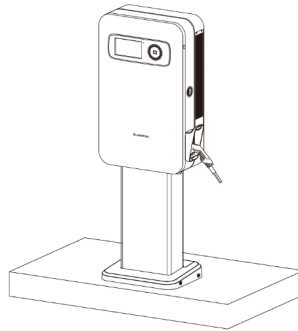

figure 2-25 Back-cover plate installation

-- End

### 2.4.6.11 Charger Connector Installation

Confirm that the charger connector socket is mounted firmly and then holster the charging connector into the charger.



**figure 2-26** The charger connector installation

### 2.4.7 Movable Charger Installation (Optional)

**Step 1** Fix the wall-mounting bracket to the cart with M8\*16 bolt assemblies.

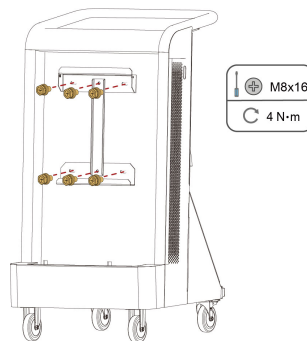

**Step 2** Place the charger on a flat surface covered with protective materials such as foam or a sponge mat.

**Step 3** Attach the upper and lower brackets to the back of the charger with M5\*12 screws.

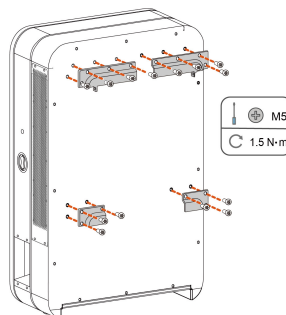

**Step 4** Remove the keyhole plugs on the left and right sides of the charger, and keep them properly for later use. Fit the handles in the corresponding holes on both sides of the charger, and tighten them.

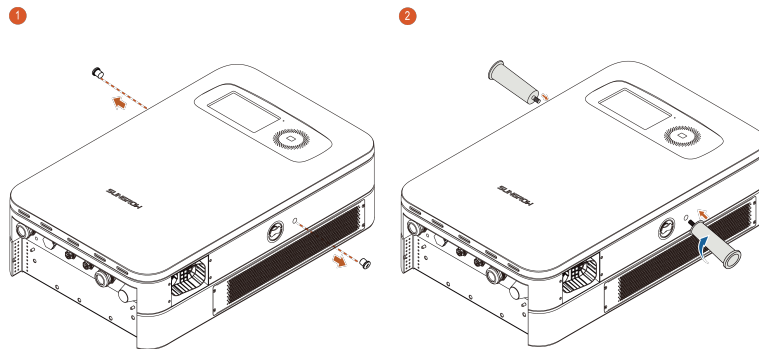

**Step 5** Lift the charger by the handles, and hook it on to the wall-mounting bracket.

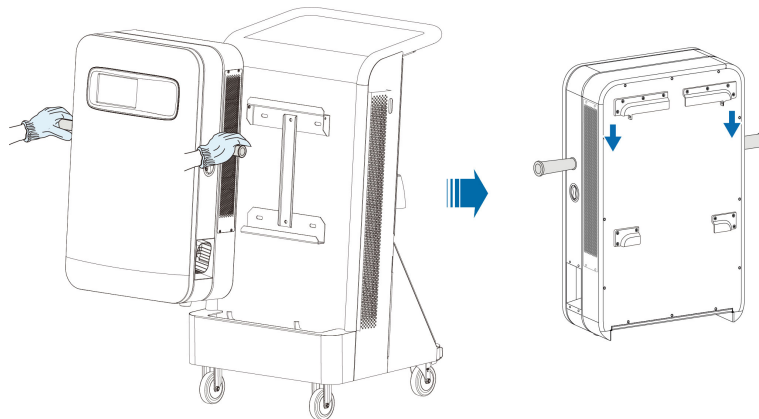

**Step 6** Disassemble the handles, and fit back the plugs removed in Step 4.

**Step 7** Fix the upper brackets on the back of the charger to the wall-mounting bracket with M5\*12 screws.

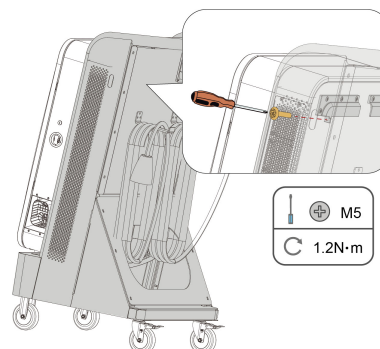

#### NOTICE

The upper brackets on both sides of the charger should be fixed to the wall-mounting bracket with screws, otherwise, the charger may not be secure.

**Step 8** For detailed information of AC terminal connection, please refer to "[2.4.5.8 Connect the Cable Connection Terminal](#)"

**Step 9** For detailed information of network connection, please refer to "[2.4.5.10 SIM Card Installation](#)" and "[2.4.5.10 SIM Card Installation](#)"

**-- End**

## 3 Interface Function Description

### 3.1 Page Introduction

#### 3.1.1 System Check

When the charger is powered on for the first time, the program starts automatically.

**Step 1** Start the program to run a system check;

**Step 2** After 30 seconds, the touch screen enters the Start page.

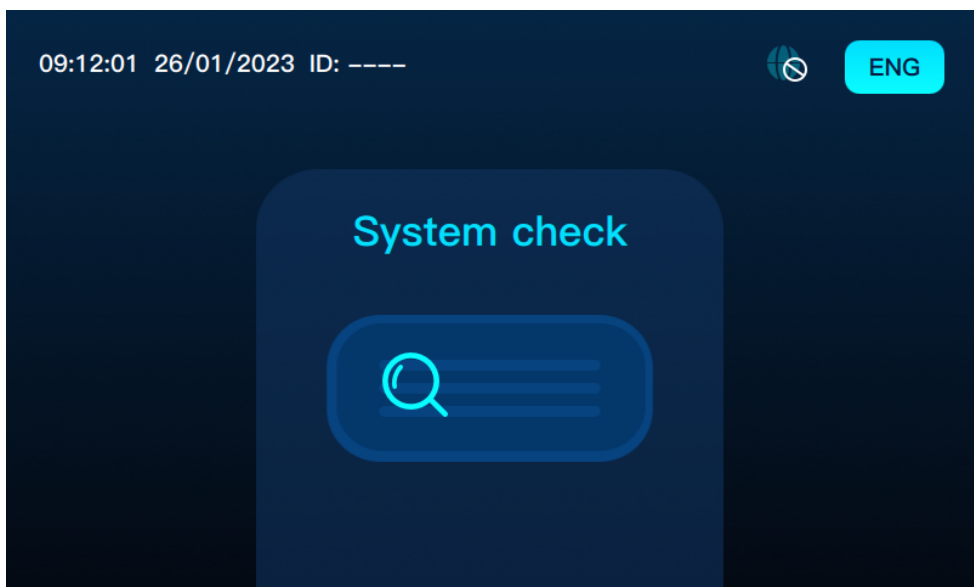

figure 3-1 System check page

-- End

#### 3.1.2 Start Page

The Start page displays the availability of the charger.

- Upper left corner: time, date and ID.
- Upper right corner: network status and language.

Please plug the connector into your vehicle.

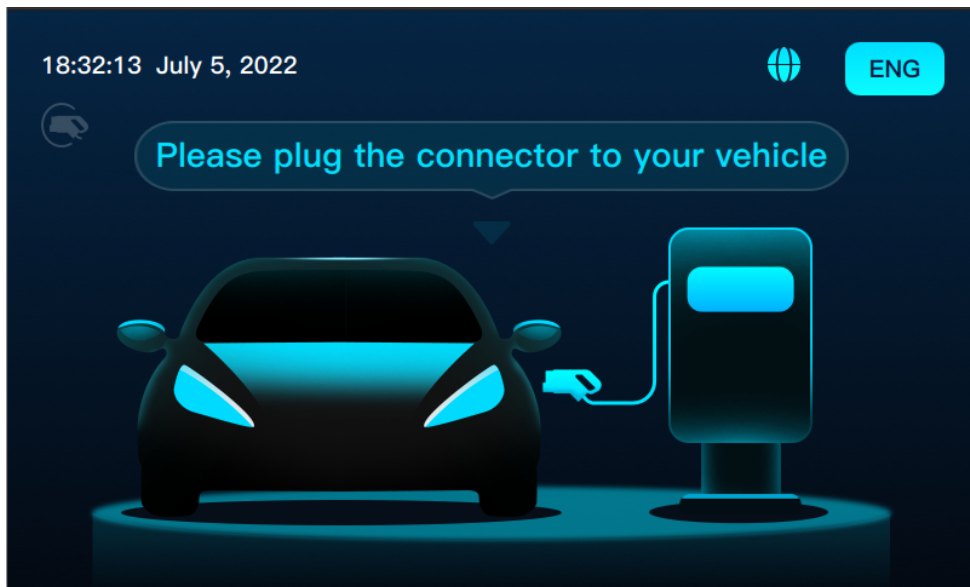

figure 3-2 The start page

If the charger is inactive for 5 minutes, the touch screen automatically enters into screen-saver mode and the backlight will be dimmed. You can touch the screen to unlock.

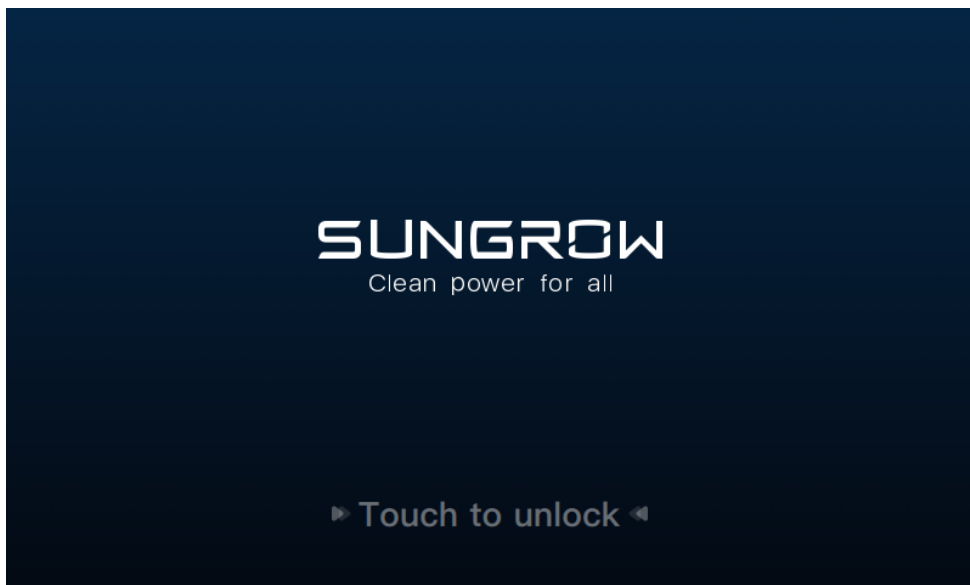

figure 3-3 The Screen-saver Page

### 3.1.3 Other Pages

In addition to the Start page, five other pages indicate different states of the charger: unavailable, emergency stop, firmware updating, offline, and abnormal.



### 3.1.3.1 Unavailable

When the charger is unavailable, the touch screen enters the Unavailable page. A warning icon and a prompt message are shown as below:

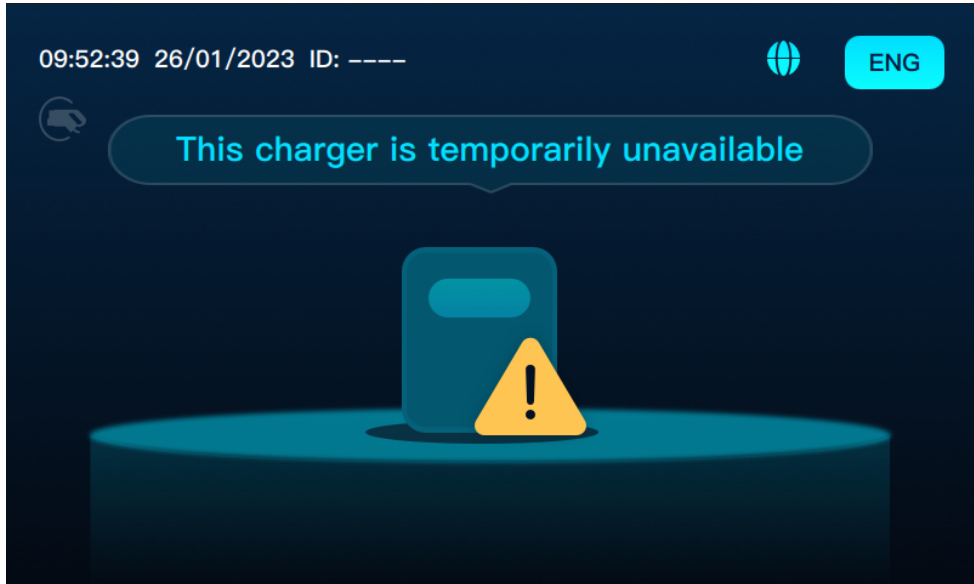

**figure 3-4** Unavailable

If you plug the charging connector when the charger is unavailable, you cannot start the charging session and are prompted with a message that says the charging point is disabled.

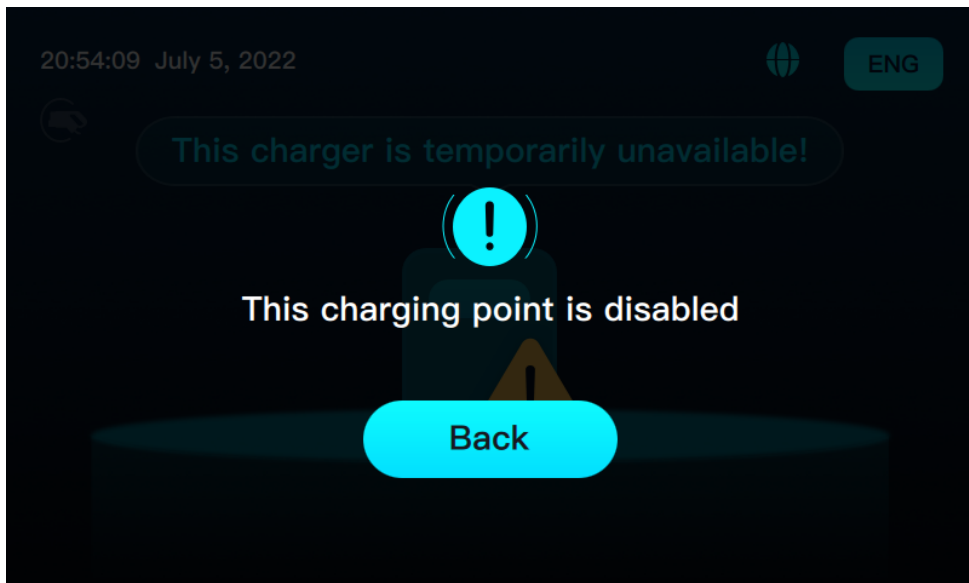

figure 3-5 Charging Point is Disabled

When the charger is available again and there are no other errors, plug the charging connector into your car and the touch screen enters the Card Swiping page according to your setting (scan to charge or Plug&Play).

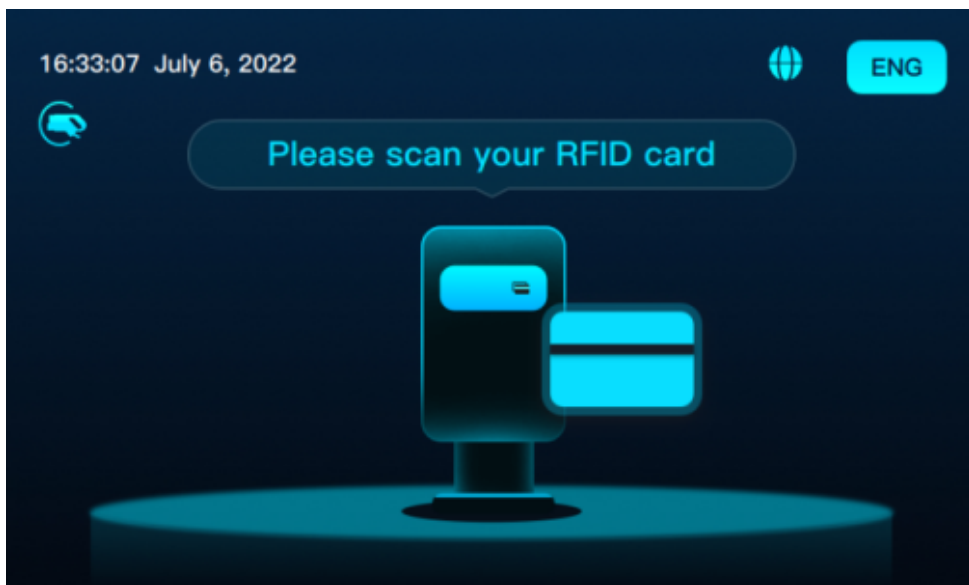
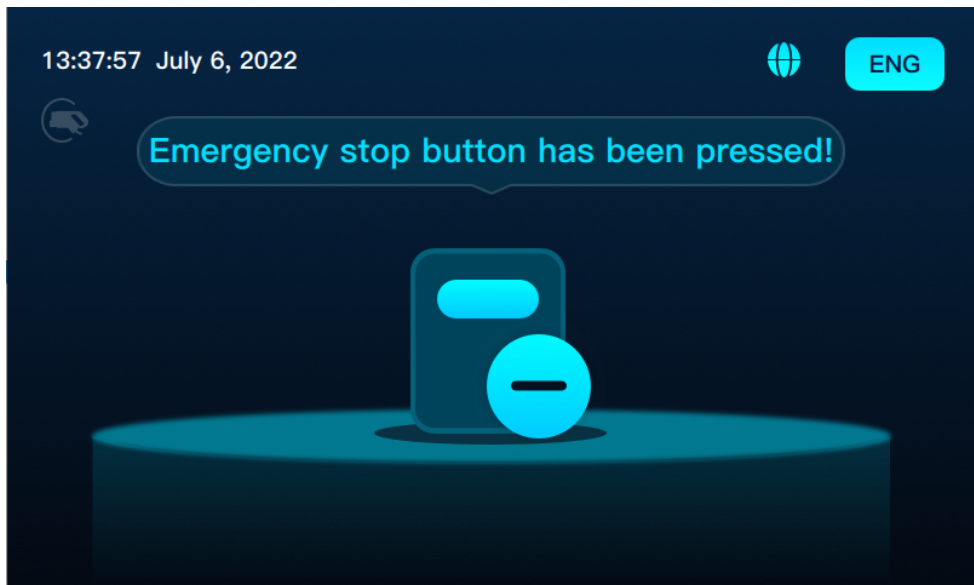

figure 3-6 Card Swiping

### 3.1.3.2 Emergency Stop

Press the emergency stop button to enter the Emergency Stop page. A stop icon and a prompt message are shown as below.



**figure 3-7** Emergency Stop

If you plug the charging connector during an emergency stop, you cannot start the charging session.

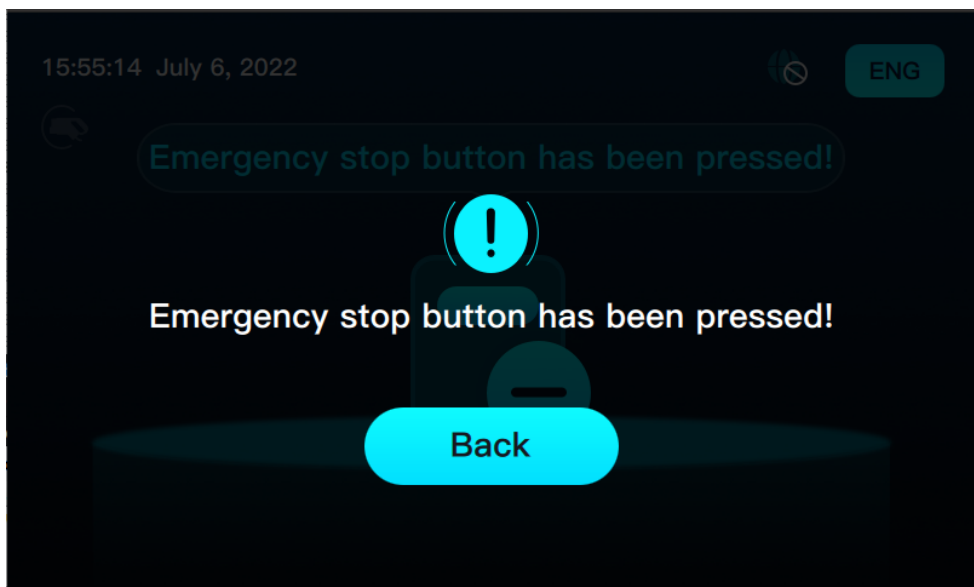

**figure 3-8** Emergency Stop Button Has Been Pressed

When the charger is available again and there are no other errors, plug the charging connector into your car and the touch screen enters the Card Swiping page according to your setting (scan to charge or Plug&Play).

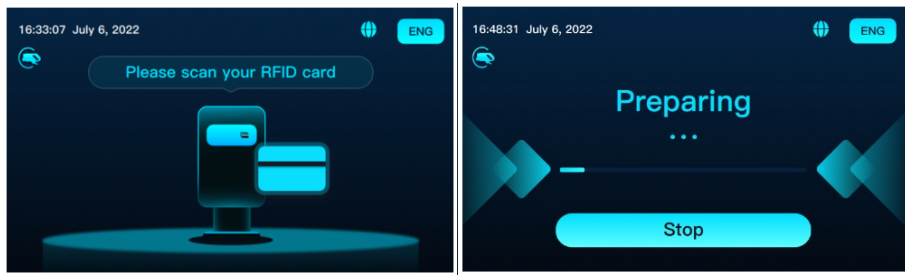

figure 3-9 Card Swiping Page or Plug & Play

### 3.1.3.3 Firmware Update

When the firmware is updating, the touch screen enters the Firmware Update page. An updating icon and a prompt message are shown as below.



During updating, do not turn off the power or enter the operating mode. The updating progress is indicated by the progress bar.

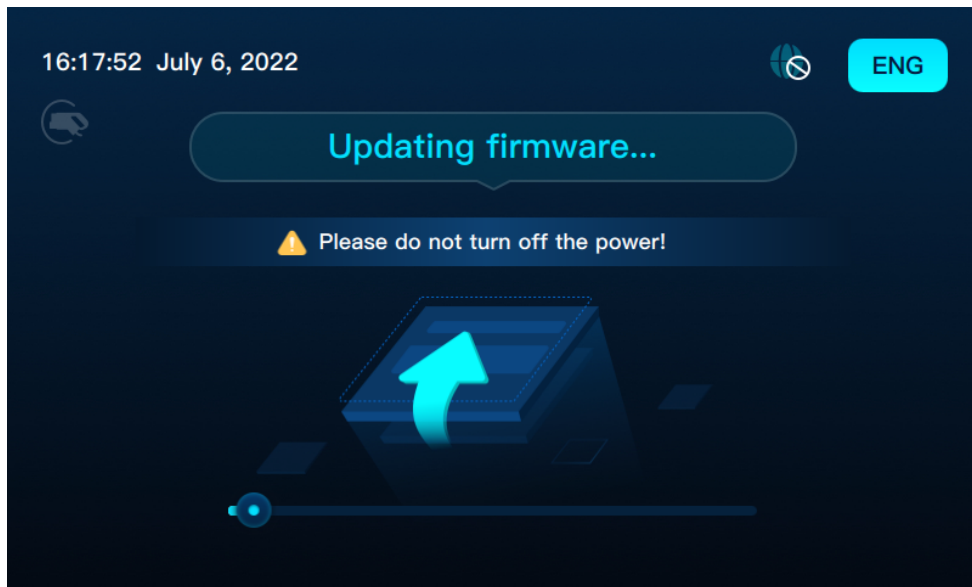

figure 3-10 Firmware Update

- The progress bar shows the present updating progress. The updating cannot be canceled once it starts.
- During updating, if you plug the charging connector into your car, the charger does not respond, and the charging connector icon is not displayed.
- Updating is not allowed during charging and does not affect your operation. The firmware only automatically updates when the charger is available.
- After the updating completes, the system reboots in 10 seconds.

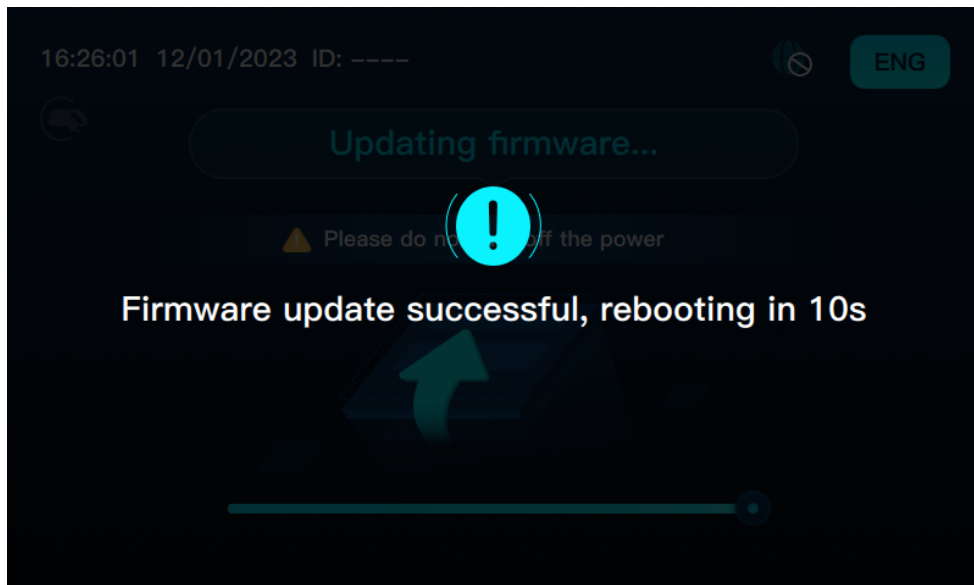

figure 3-11 Rebooting

#### 3.1.3.4 Offline

When the charger is offline, an icon is displayed on the upper right side of the page.

The charger is offline because,

- 1 the network is connected, but the OCPP platform cannot be connected (!);



figure 3-12 Icon Displayed When There is a Network Connection

- 2 the network is disconnected, and the OCPP platform cannot be connected (\).



figure 3-13 Icon Displayed When There is No Network Connection

#### 3.1.3.5 Abnormal

When the charger runs abnormally, a message that says a technical issue occurred appears in the touch screen.

**Step 1** Click Back.

**Step 2** The touch screen enters the Unavailable page.

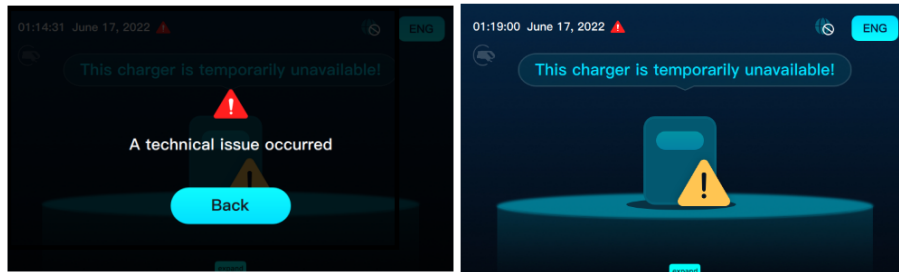

**figure 3-14** A technical issue occurred



When an error occurs, a warning icon indicating that the charger cannot be used appears in the touch screen.



**Step 3** Click  or plug the charging connector directly. A warning message appears.

**Step 4** Click Back, and the Unavailable page appears.

-- End

### 3.1.3.6 Language Settings

**Step 1** Click  in the upper right corner to enter the Language Settings page.

**Step 2** Click the flag icon to choose the corresponding language.

**Step 3** Click the Confirm button to exit the Language Settings page.

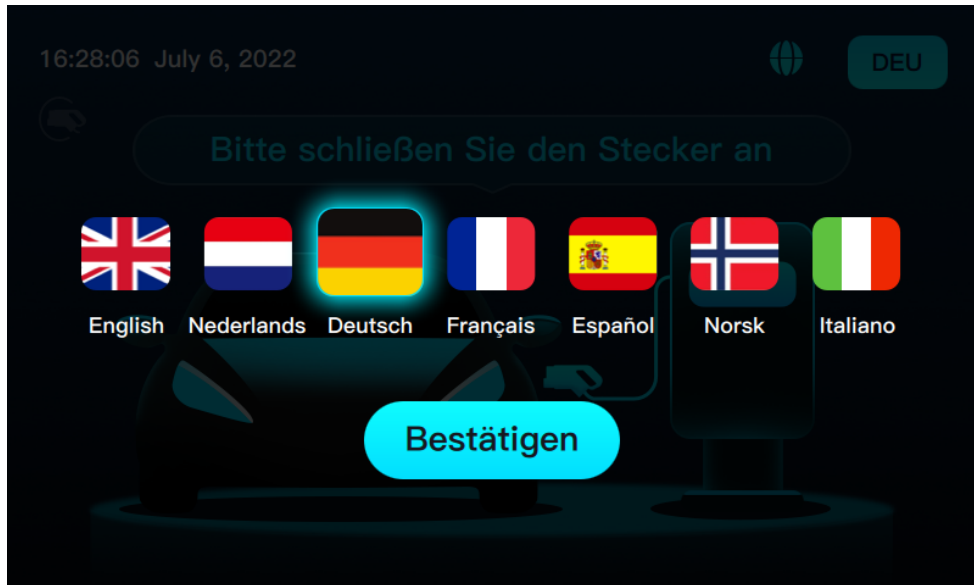

**figure 3-15** Language Settings

After switching languages, the language setting icon becomes the abbreviation of the first three letters of the corresponding language.



The language of the page will be switched to the selected language.

The Language Setting page appears whenever you clicked the button in the upper right corner.

-- End

## 3.2 Charging

### 3.2.1 Plug the Charging Connector

**Step 1** Touch any position on the screen.

**Step 2** Activate the touch screen to enter the Start page.

**Step 3** Plug the charging connector into your vehicle.

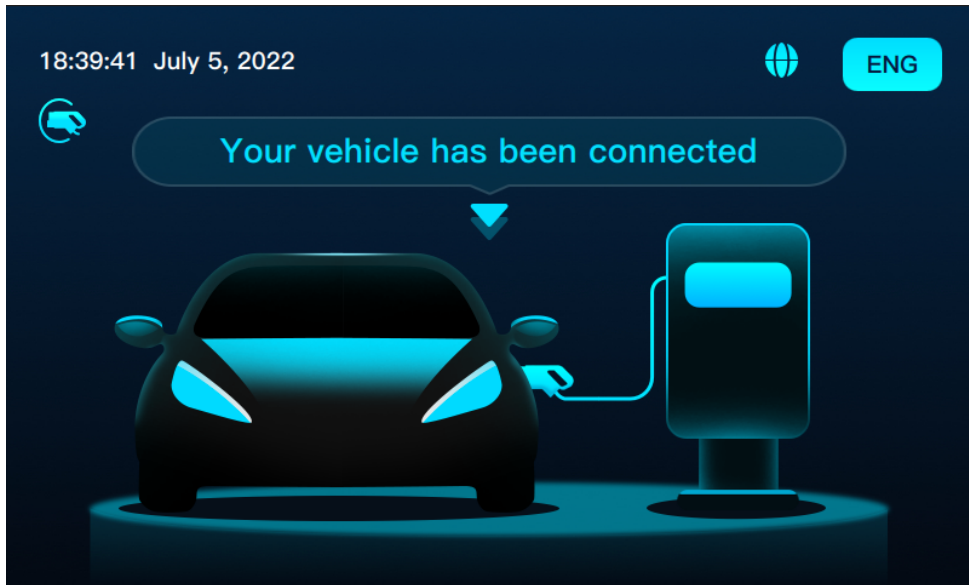

**figure 3-16** Your Vehicle Has Been Connected

-- End

## 3.2.2 Charging Method

### 3.2.2.1 Charging via RFID Card

#### Swipe Card

- 1 When the charging connector is plugged into your car, the plugging icon is lit, and the touch screen enters the Card Swiping page.
- 2 After swiping card, the touch screen enters the Authentication page, and the progress bar changes from small to large.
- 3 According to the feedback of the OCPP platform, the card-swiping result is displayed.

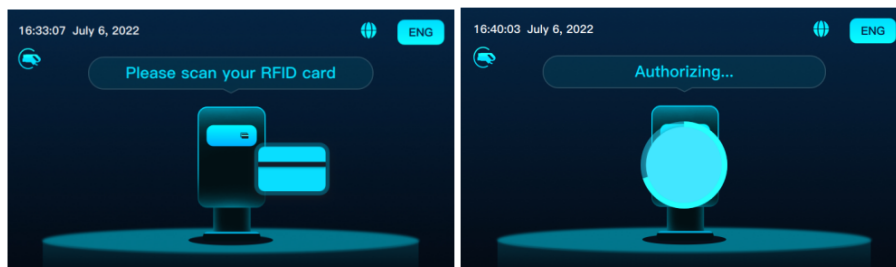

**figure 3-17** Card Swiping

**Authorization success:** You can see a check and a message says that the authentication is successful.

**Authorization failure:** If the card cannot be used or recognized, the OCPP platform returns a different message:



- The card cannot be recognized.
- The card is banned.
- The card is expired.
- The card is occupied.
- Unknown error.
- The card is not in the local list (only for offline mode).

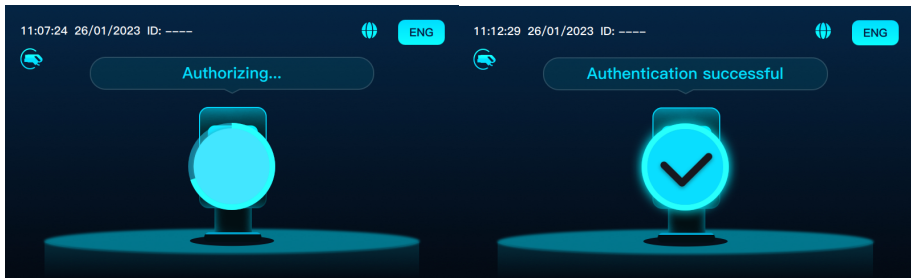

figure 3-18 Authentication /Authentication Successful

### In Preparation

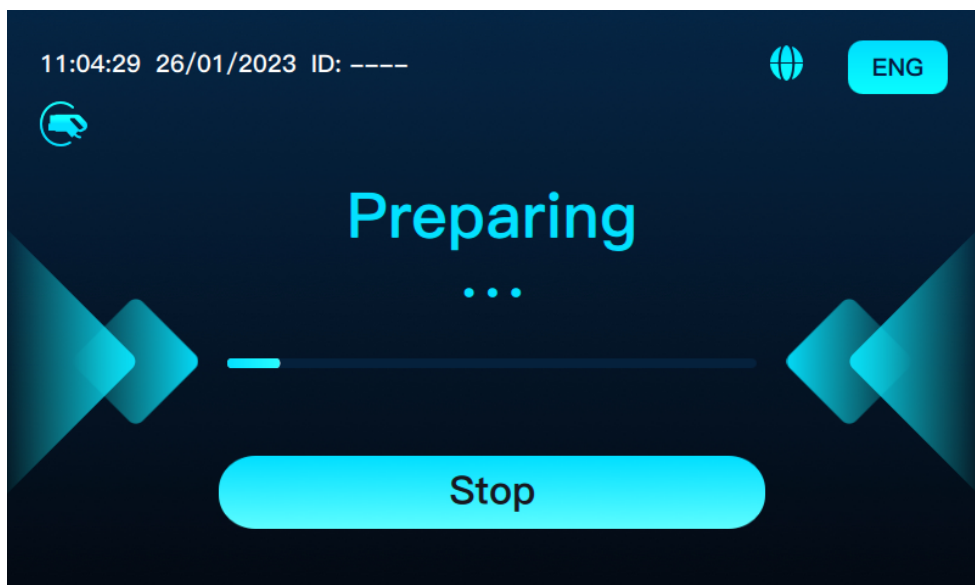



figure 3-19 Preparing

- When the charger is preparing, use the charge card or the stop button to terminate the charging session. For more information, see "Stop Charging".
- If you unplug the charging connector when the charger is preparing, the touch screen returns to the Start page.
- When the charging is interrupted or the emergency stop button is pressed, the touch screen enters the Charging Finished page. If the charging is interrupted due to errors, the touch screen enters the corresponding page after you unplug the charging connector.

**NOTICE**

- **When the charging is interrupted during the preparation stage (such as unplugging the charging connector, malfunctioning, pressing the emergency button), the touch screen enters the Charging Finished page.**
- **If the charging connector is unplugged in other situations, the touch screen enters the Start page.**

**During Charging**

During charging, information is displayed on the following two screens. Click  and  to switch.

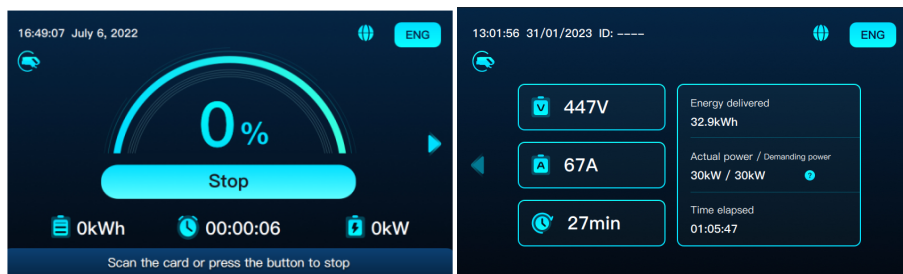

**figure 3-20** The First Screen/The Second Screen

**The First screen:** Key information includes

- Charging progress (SOC)
- Battery level
- Time used
- Charging power
- The Stop button
- Message of stopping charging via RFID charge card

**The Second screen:** Secondary information includes

- Real-time charging voltage
- Real-time charging current
- Remaining charging time (displayed as "-" if not provided by the vehicle)
- Energy delivered
- Actual power (the output power of the charger)
- Demanding power (the output power of the vehicle)

On the second screen, select  on the right will display the status of the charger:



- Charging power is limited by the charger
- Charging power is limited by the vehicle
- Charge at the maximum power



If the charger is inactive for 5 minutes, the touch screen automatically enters screen-saver mode and the backlight will be dimmed. You can touch the screen to exit the screen-saver mode.

### Stop Charging

There are two ways to stop charging: 1. Swipe the RFID charge card; 2. Press the Stop button.

- RFID charge card to stop
  - 1 During preparation or charging, swipe the RFID charge at any time.
  - 2 If successful, you are prompted to confirm the end of the charging session.
  - 3 Click Confirm to stop charging and the touch screen returns to the Charging Finished page.
  - 4 Click Cancel and the prompt message disappears.



If you swipe a different RFID card to stop charging, you will be prompted to use the previous RFID card.

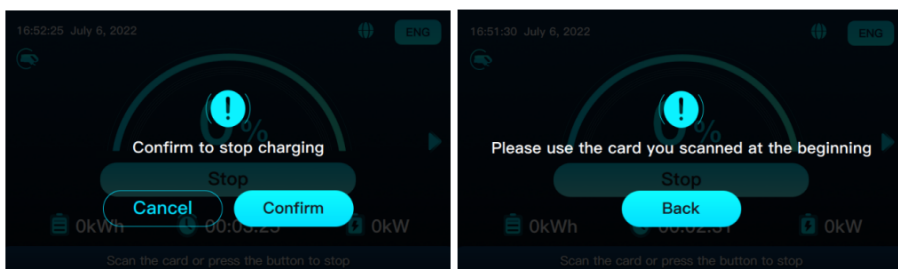



figure 3-21 Confirm to Stop Charging/Use the previous RFID Card

### Press to Stop

- 1 During charging, click  and you are prompted to swipe RFID card to stop.
- 2 After swiping the card, the charging immediately stops and the Charging Finished page appears.
- 3 Click  and the touch screen returns to the Start page.



If you swipe a different RFID card to stop charging, you will be prompted to use the previous RFID card.

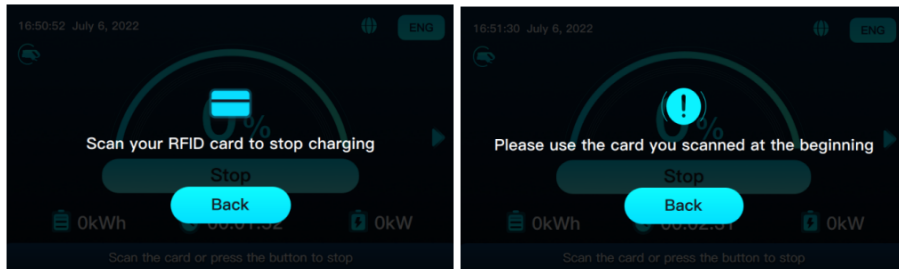

**figure 3-22** Scan your card to stop charging/Use the previous RFID Card



There is no stop button on the second screen, you can either return to the first screen or swipe the card to stop charging.

### Charging Finished

When the vehicle is fully charged, you stop the charging session manually, or an abnormality occurs, the Stopping page appears.

After the charging session is completed, the Charging Finished page appears. Related information including total battery level and time used appears, and you are prompted to unplug the charging connector.

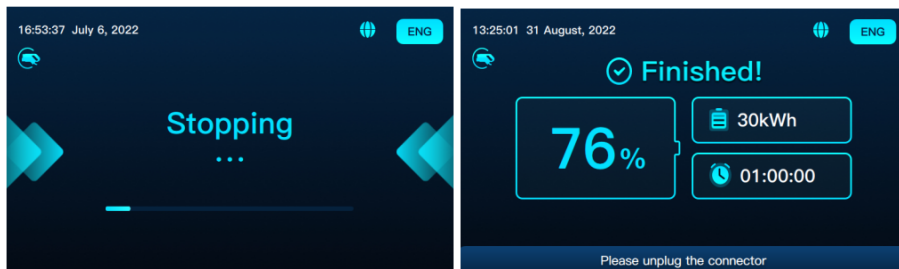

**figure 3-23** The Stopping Page/The Charging Finished Page

During charging, if you unplug the charging connector, the touch screen enters the Charging Finished page.

Follow the prompt message and press the home button to start charging.

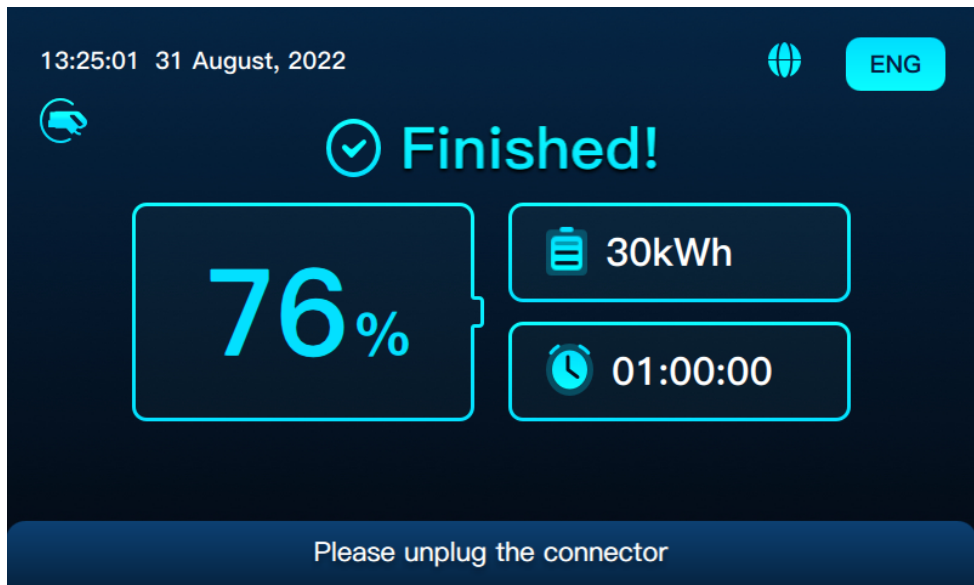

figure 3-24 The Charging Finished Page

### 3.2.2.2 Plug&Play

The overall charging process is different from that of Charging via RFID card in :

- No RFID charge card.
- When the charging connector is plugged into the vehicle, the touch screen enters the Preparing page
- The charging starts after the preparation is completed.

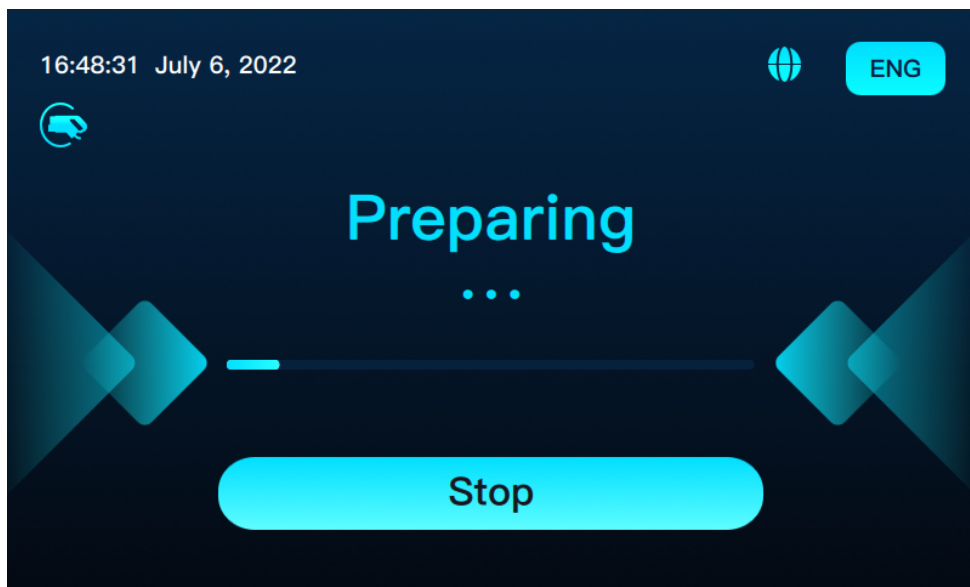



figure 3-25 Preparing

**Stop charging:** Stop the the charging session from the vehicle or the touch screen. Press the  button to stop.

**Complete charging:** Unplug the connector to complete the charging.

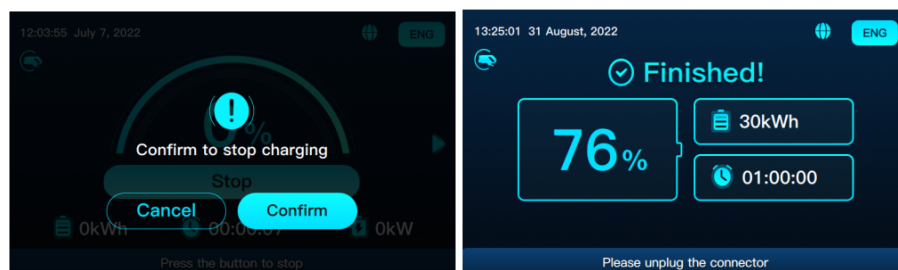

figure 3-26 Confirm to Stop Charging/ The Charging is Completed

## 4 Operation and Maintenance Mode

### 4.1 Login and Logout

#### 4.1.1 Login

**Step 1** Press the date and time zone in the upper left corner of any page for 1.5 seconds.

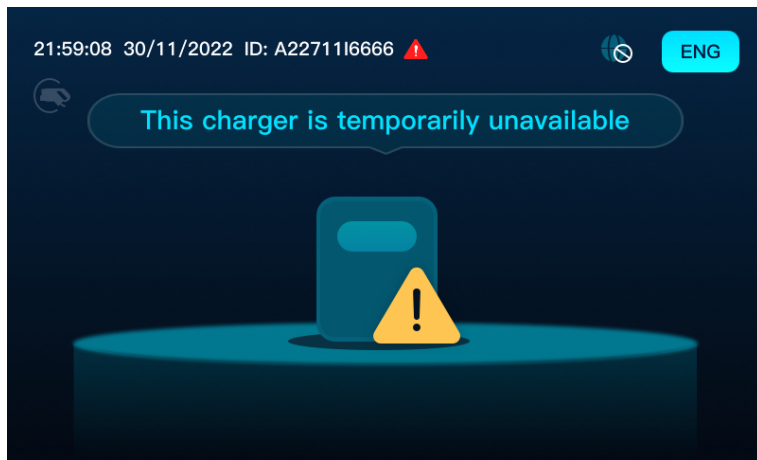

figure 4-1 Client

**Step 2** In the pop-up dialog box, enter the password 202207 and click **Enter**.

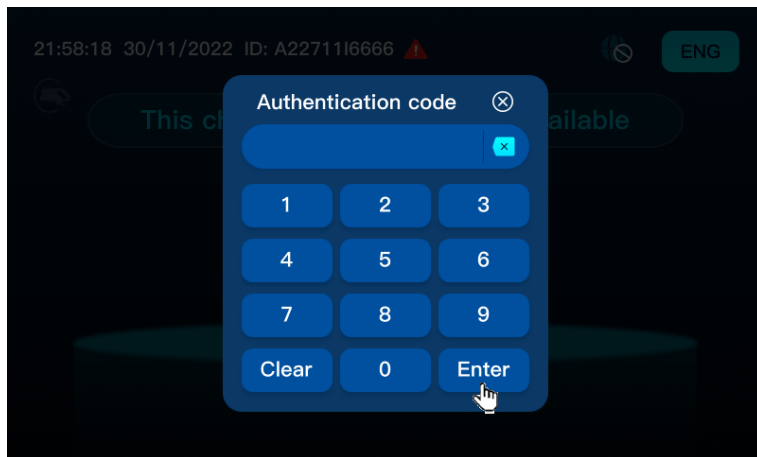

figure 4-2 Password input box



The password 202207 is for **Read-only**. If you need other authorities, please refer to "Operation and Maintenance Mode" or contact SUNGROW customer service.

-- End

## 4.1.2 Logout

Click  to return to the initial page.

The screenshot displays the 'CCU\_Info' page with the following data:

| Section                        | Parameter                          | Value   |
|--------------------------------|------------------------------------|---|
| Monitoring & System Data: CCU1 | Monitoring:                        | CCU 1   |
|                                | Cabinet Temp(°C):                  | 0.0   |
|                                | Gun Temp(°C):                      | P:0   N:0                                       |
|                                | System Status:                     | Normal  |
|                                | Gun Status:                        | Idle  |
|                                | Output Voltage (V):                | 0   |
|                                | Request Voltage (V):               | 0   |
|                                | Output Current (A):                | 0   |
|                                | Request Current (A):               | 0   |
|                                | Current SOC %:                     | 0   |
|                                | Remain Time (min):                 | 0   |
|                                | Venti-Fan1 speed (r/min):          | 0   |
|                                | Venti-Fan2 speed (r/min):          | 0   |
| Setting & Control:             | Connector:                         | CCU 1   |
|                                | DC Current Limit(A):               | 70  |
|                                | Power Limit(kW):                   | 30  |
| General Control:               | Serial number:                     | A22711I6666                                     |
|                                | Current Error info                 |   |
|                                | History Error info                 |   |
|                                | General Cabinet Fault Temperature: | Recovery Point (°C): 70<br>Alarm Point (°C): 80 |

figure 4-3 Operation & Maintenance Page

## 4.2 Function Description

### 4.2.1 CCU Info

Select "CCU\_Info" from the navigation bar to turn to the CCU\_Info page. The CCU\_Info page contains two pages: user page and administrator page.

The following description takes the administrator page for example.

- 1 Setting&Control-> Connector, drop the menu down;
- 2 Select the CCU number (connector number). CCU number determines the data displayed on the CCU\_Info page.



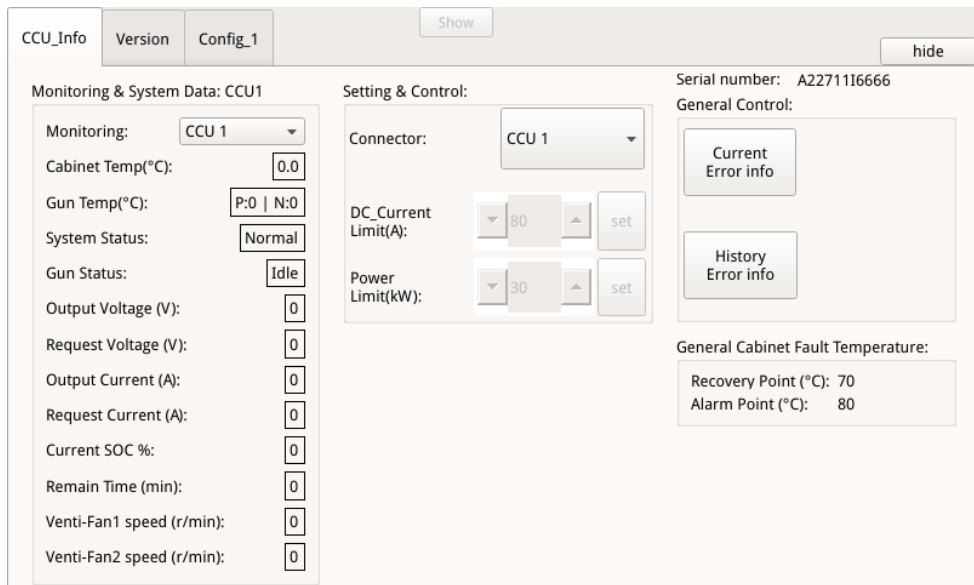

figure 4-4 Administrator page

The CCU\_Info page mainly contains:

- System status display column "System Data"
- Real-time error information "Current Error info"
- History error information "History Error info"
- General Control "Setting&Control"
- Cabinet fault temperature "Cabinet Fault Temperature"

#### Monitoring&System Data:CCU1

Monitoring, cabin temperature, connector temperature, system status, connector status, output voltage, requested voltage, output current, requested current, Current SOC, remain time, venti-fan1 speed, venti-fan2 speed.

Monitoring & System Data: CCU1

Monitoring:

Cabinet Temp(°C):

Gun Temp(°C):

System Status:

Gun Status:

Output Voltage (V):

Request Voltage (V):

Output Current (A):

Request Current (A):

Current SOC %:

Remain Time (min):

Venti-Fan1 speed (r/min):

Venti-Fan2 speed (r/min):

figure 4-5 Monitoring&System Data:CCU1

## Setting&Control

Setting & Control:

Connector:

DC\_Current Limit(A):

Power Limit(kW):

figure 4-6 Setting&Control

- 1 Click  or  to adjust the maximum current/power of the CCU;
- 2 Click "Set" to set the CCU local charging current/voltage, and each CCU corresponds to the maximum current/power output by a connector;

## General Control

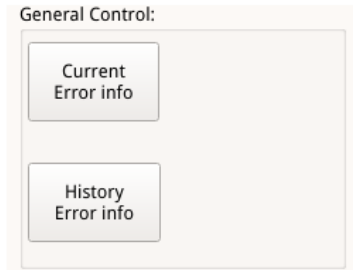

**figure 4-7** General Control

### Current Error Info.

- 1 Click "Current Error info" to display the real-time error information in the pop-up dialog box;
- 2 Click "Close" to close the dialog box.

### History Error Info

- 1 Click "History Error info" to display history error information in the pop-up dialog box;
- 2 Click "Earlier Page", "Newer Page" and "Newest Page" to switch the pages;
- 3 Click "Close" to close the dialog box.

## General Cabinet Fault Temperature

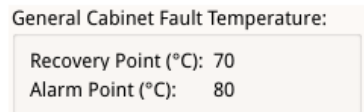

**figure 4-8** General Cabinet Fault Temperature

**Alarm Temperature:** When the cabinet temperature exceeds Alarm temperature, the charger derates or stops.

**Recovery temperature:** When the cabinet temperature is lower than the Recovery temperature, the original output capacity is restored.

## 4.2.2 Version

The screenshot shows the 'Version' tab in the Administrator interface. It is divided into two main sections: 'Firmware Version' and 'Update'.

**Firmware Version:**

- Back-end id: 1.1.3-alpha+BakFrt'
- TCU All:
- TCU Back: 09.0E1.A01.001.12
- TCU Front: 09.0E1.B01.001.12
- TCU Source: 09.0E1.C01.001.02
- TCU Script: 09.0E1.D01.001.11
- TCU Json: 09.0E1.E01.001.03
- TCU Java: 09.0E1.F01.001.09
- CCU 1: 02.0E1.000.001.15
- MDSP 1: 03.001.003.003.06
- SDSP 1: 04.001.003.003.06

**Update:**

- Target Device: CCU
- Index of Device: 1
- Firmware Source: USB
- Update State: (Greyed out)
- Update Device: (Button)

figure 4-9 Administrator page

The Version page mainly contains:

- "Firmware Version"
- "Update"

### Firmware Version

The screenshot shows the 'Firmware Version' section with the following details:

- Back-end id: 1.1.3-alpha+BakFrt'
- TCU All:
- TCU Back: 09.0E1.A01.001.12
- TCU Front: 09.0E1.B01.001.12
- TCU Source: 09.0E1.C01.001.02
- TCU Script: 09.0E1.D01.001.11
- TCU Json: 09.0E1.E01.001.03
- TCU Java: 09.0E1.F01.001.09
- CCU 1: 02.0E1.000.001.15
- MDSP 1: 03.001.003.003.06
- SDSP 1: 04.001.003.003.06

figure 4-10 Firmware version

### Update



Local update via USB drive is available in case that the Internet is unavailable.

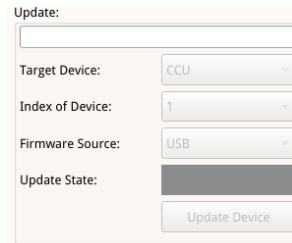

Update:

Target Device: CCU

Index of Device: 1

Firmware Source: USB

Update State:

Update Device

**figure 4-11** Update

- 1 Insert the USB drive and store the description file of the new firmware and the corresponding firmware in the root directory;
- 2 Click the "Target Device" drop-down menu to select target CCU/MDSP/SDSP/TCU ALL to be upgraded;
- 3 Click the "Index of Device" drop-down menu. Select the number of the corresponding module (Note: Select 1 for single connector model; Select 1 for double connector model when upgrading TCU and select the corresponding module number when upgrading other modules.);
- 4 Click the "Firmware Source" drop-down menu and select "USB";
- 5 Click "Update Device" to complete the updating;
- 6 After automatic restart, pull out the USB drive;
- 7 If you need to update multiple modules, repeat the above steps.

### 4.2.3 Config\_1

Select "**Config\_1**" from the navigation bar to enter the Config\_1 page. The Config\_1 page contains two types: user page and administrator page.

The following description takes the administrator page for example.

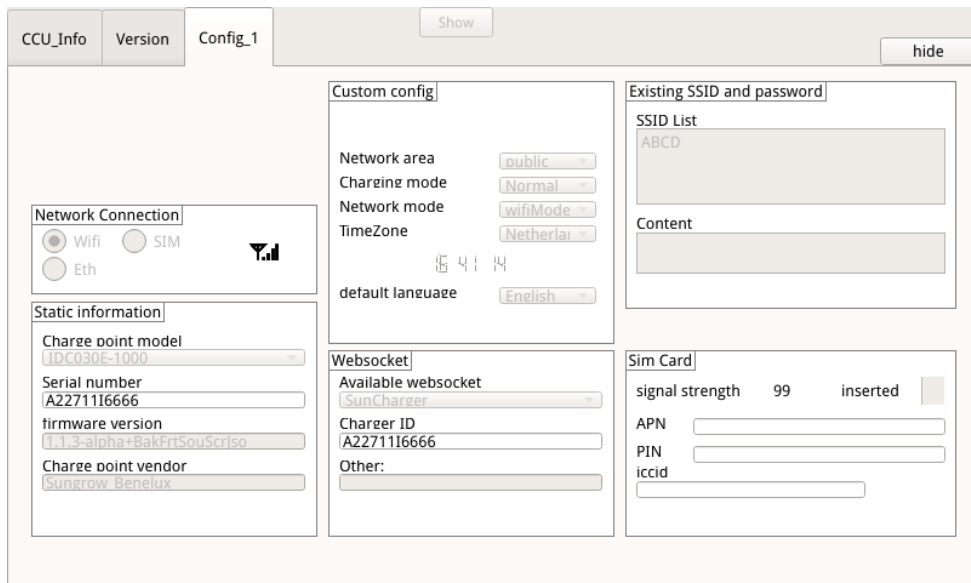

figure 4-12 Administrator page

The Config\_1 page mainly contains:

- "Network Connection"
- "Static information"
- Custom configuration "Custom config"
- Cloud Access Point "Websocket"
- WIFI Name and Password "Existing SSID and password"
- SIM information configuration "Sim Card"

#### Network Connection



figure 4-13 Network Connection

TCU provides three network connection modes: "WIFI mode", "SIM mode" and "Eth mode".

## Static Information

| Static information  |                 |
|---------------------|-----------------|
| Charge point model  | IDC030E-1000    |
| Serial number       | A22711I6666     |
| firmware version    | 1.0.0-alpha+Sou |
| Charge point vendor | Sungrow Benelux |

**figure 4-14** Static Information

Displays charge point model, serial number, firmware version and charge point vendor.

## Custom Config

| Custom config    |           |
|------------------|-----------|
| Network area     | public    |
| Charging mode    | Normal    |
| Network mode     | wifiMode  |
| TimeZone         | Netherlai |
| 16:41:14         |           |
| default language | English   |

**figure 4-15** Custom config

Displays network area charge mode, network mode, time zone and default language.



Network Area: Public and Private.

- Public: The DC Charger can connect to the Internet.
- Private: The DC Charger can connect to the CPO platform only.

## Websocket

| Websocket           |             |
|---------------------|-------------|
| Available websocket | SunCharger  |
| Charger ID          | A22711I6666 |
| Other:              |             |

**figure 4-16** Websocket

Displays available websocket, charger ID and other.

### Existing SSID and Password

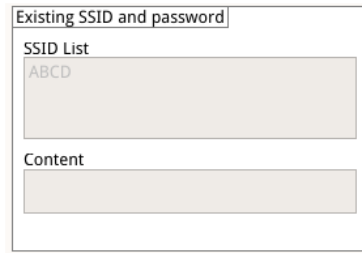

**figure 4-17** Existing SSID and password

Displays SSID list and content.

### Sim Card

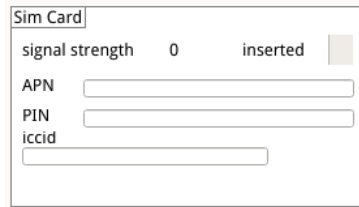

**figure 4-18** Sim card

Displays APN, PIN and iccid.



## 5 iEnergyCharge App

iEnergyCharge App is a tool that allows users to operate and manage their EV chargers. Users can complete account settings and charger configuration, manage charge cards, operate the charger, and reach customer service on the App.



Depending on the version of iEnergyCharge you are using, the user interface might be slightly different.

### 5.1 Download and Installation

#### Operating System:

- Android 6.0 or later
- iOS 11 or later

#### Option 1

Download the App from the below application stores and install it on your device:

- Google Play
- App Store

#### Option 2

Scan the QR code below, and download and install the App by following the onscreen instructions.



### 5.2 Sign-up and Log in

**Step 1** Open the iEnergyCharge App, and tap **Sign up**.

**Step 2** Enter an email address, and tap **Next**.

**Step 3** Find the verification code sent by the system in your email inbox. Then, go back to the App, enter the verification code, and tap **Next**.

**Step 4** Enter a password, and the sign-up process is now completed. You will then go to the App's **Home** screen.

-- End

### 5.3 Add a Charger

To add a charger to your account on the iEnergyCharge App for operation and management.

**Step 1** Tap **Add device** on the **Home** screen. Scan the QR code on the side of the charger, or enter the charger S/N to add a charger to your account.

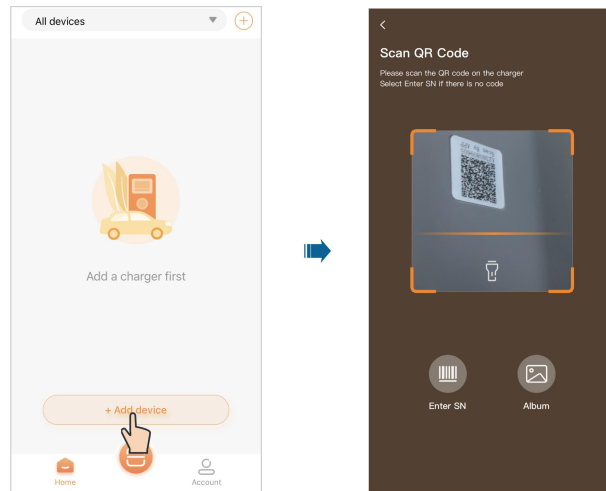

-- End

For more detailed information regarding the use of iEnergyCharge App, see [iEnergyCharge User Manual](#). You can also open the App and choose “**Account**→**Settings**→**User Manual**” to view the manual.

## 6 Faults and Troubleshooting





All fault codes are displayed in operation and maintenance mode. If the fault still persists after troubleshooting, please contact SUNGROW customer service.

### 6.1 TCU

table 6-1 TCU faults and troubleshooting

| Displaying text                | Fault cause  | Solutions  |
|--------------------------------|--|--|
| 0Err_TCU_CCUComm_Error         | The communication between the CCU and TCU is lost              | <ol style="list-style-type: none"><li>1. Check the ethernet cable connection, make sure that the ethernet cable is properly connected between RJ45 of the CCU and the "eth0" of the TCU</li><li>2. If the problem persists, turn off the charger's main power switch, wait for 20 seconds, and turn on again</li><li>3. If the problem persists, please contact SUNGROW Customer service</li></ol>   |
| 1Err_TCU_CardReader_Comm_Error | The communication between the RFID card reader and TCU is lost | <ol style="list-style-type: none"><li>1. Check the connection terminal of the RFID reader. Make sure the red led light is alive on the RFID reader. If it is not, check if the cable connections on the "Reader" terminal block of TCU are still tight</li><li>2. If the problem persists, turn off the charger's main power switch, wait for 20 seconds, and turn it on again</li><li>3. If the problem persists, please contact SUNGROW Customer service</li></ol> |

| Displaying text  | Fault cause  | Solutions   |
|--|--|---|
| 2Err_TCU_DCMeter0_Comm_Error   | The communication between the DC meter and TCU is lost                     | <ol style="list-style-type: none"> <li>1. Check the connection terminal of the DC meter. Make sure the display and led is alive on the DC meter. If it is not, check if the cable connections on the DC meter's terminal blocks are still tight</li> <li>2. If the problem persists, check if the cable connections on "RS485-1" terminal block of TCU are tight</li> <li>3. If the problem persists, turn off the charger's main power switch, wait for 20 seconds, and turn it on again</li> <li>4. If the problem persists, please contact SUNGROW Customer service</li> </ol>   |
| The network is unreachable  | The internet connection between the charger and the public network is lost | <ol style="list-style-type: none"> <li>1. Charger is connected to the internet via wifi: <ol style="list-style-type: none"> <li>a. check if the wifi router is working properly.</li> <li>b. If the wifi is available for the other device, long press the top left area of the screen, enter the password in the keyboard panel (default code 202207). In the pop out maintenance page, click Config_1, and check if the network mode is set to Wifi, and check if the ssid and the password is correct</li> <li>c. If the problem persists, please contact SUNGROW Customer service</li> </ol> </li> <li>2. Charger is connected to the internet via SIM card: <ol style="list-style-type: none"> <li>a. check if the SIM card is inserted properly. Enter the maintenance page, click Config_1, check the "Inserted" checkbox is checked in "Sim config" area. If it is not, plug out and re-insert the SIM card into the TCU, turn off the main switch, wait for 20 seconds, and turn on.</li> <li>b. Check if the 4g attenet is connected properly with the 4g(M) header</li> <li>c. If the problem persists, please contact SUNGROW Customer service</li> </ol> </li> </ol> |

| Displaying text   | Fault cause   | Solutions   |
|---|---|---|
| The OCPP backend is unreachable  | The internet connection between the charger and the OCPP backend is lost      | <ol style="list-style-type: none"> <li>1. Restart the charger</li> <li>2. If the problem persists, go to the maintenance page, click Config_1 page, check if the websocket on the websocket area is correct. If it is not, input or select the correct websocket address</li> <li>2.If the problem persists, on the maintenance page, check the charger id and serial number on the Config_1 page. If the charger id does not match the one which was registered in the OCPP backend, input the correct one. If the serial number does not match the one on the name plate, please contact SUNGROW Customer service</li> <li>3. If the problem persists, please contact SUNGROW Customer service</li> </ol> |
| Your card has been blocked  | The RFID card is registered in the OCPP back-end, but it is currently blocked | <ol style="list-style-type: none"> <li>1. Contact with the OCPP back-end server provider, check if your RFID card is blocked by the back end</li> <li>2. If the server provider cannot provide the solutions, please contact SUNGROW Customer service</li> </ol>  |
| Your card has expired   | The RFID card is registered in the OCPP backend, but it is currently expired  | <ol style="list-style-type: none"> <li>1. Contact with the OCPP back-end server provider, check if your RFID card is already expired in the back-end server</li> <li>2. If the server provider cannot provide the solutions, please contact SUNGROW Customer service</li> </ol>   |
| Unable to identify your card  | The RFID card is not registered in the OCPP back-end server                   | <ol style="list-style-type: none"> <li>1. Contact with the OCPP back-end server provider, check if your RFID card is properly registered in the back-end server</li> <li>2. If the server provider cannot provide the solutions, please contact SUNGROW Customer service</li> </ol>   |

| Displaying text                                   | Fault cause   | Solutions   |
|---|---|---|
| This card is being used, please use another card  | The RFID card is currently occupied by one another transaction                                | <ol style="list-style-type: none"> <li>1. Check if the RFID has already been used for one another charging process. If it is, this RFID card will be unavailable until the corresponding charging session is ended</li> <li>2. Contact with the OCPP back-end server provider, check if there is an invalid transaction linked to your RFID card. Ask the back-end provider to manually end the invalid transaction</li> <li>3. If the problem persists, please contact SUNGROW Customer service</li> </ol> |
| Please use the card you scanned at the beginning  | The RFID card that is used for ending the charging session, is not the one which started it   | <ol style="list-style-type: none"> <li>1. Check if the RFID that you used is the one which started the charging session. Try the card that you used for starting this charging session</li> <li>2. If the problem persists, please contact SUNGROW Customer service</li> </ol>  |
| This charging point is unavailable                | The charger has some technical issues, or the charger is blocked by the OCPP back-end service | <ol style="list-style-type: none"> <li>1. Contact with the OCPP back-end server provider, check if the charger is set as unavailable in the back end. If so, set the charger back to available status</li> <li>2. If the problem persists, go to the maintenance page, click CCU_Info, click ""Current error info"" button, check the error strings and follows the instructions of the other errors in this table, please contact SUNGROW Customer service</li> </ol>                                      |
| Unable to initiate charging, replug and try again | Reserved  | -   |
| Sorry, this charger is temporarily out of service | Reserved  | -   |

| Displaying text                        | Fault cause                               | Solutions   |
|--|---|---|
| Emergency stop button has been pressed | The emergency button has been pressed     | <ol style="list-style-type: none"> <li>1. Check if the emergency button has been pressed. If it is, release the button</li> <li>2. If the problem persists, please contact SUNGROW Customer service</li> </ol>  |
| Charging request timeout, please retry | The charging process handshake is timeout | <ol style="list-style-type: none"> <li>1. Plug out the charging connector, re-plug it in the vehicle, and try to start a charging session again</li> <li>2. If the problem persists, restart the charger, and repeat step 1 again</li> <li>3. If the problem still persists, please contact SUNGROW Customer service</li> </ol> |

## 6.2 CCU

table 6-2 CCU Faults and troubleshooting

| Displaying text                                    | Fault cause                         | Solutions                                       |
|--|-------------------------------------|---|
| 0Err_Sys_System_Fan_1_Failed_Warning               | Fan Failure                         | Replace the fan.                                |
| 1Err_Sys_System_Fan_2_Failed_Warning               | Fan Failure                         | Replace the fan.                                |
| 2Err_Sys_CCU_Motherboard_Volatge_Abnormal_Alarm    | The system voltage Abnormal.        | Restart, if invalid, replace the control board. |
| 3Err_Sys_AC_Contactor_not_Drop_out_Alarm           | The AC contactor is faulty.         | Replace the AC contactor.                       |
| 4Err_Sys_AC_Contactor_not_Pick_up_Alarm            | The AC contactor is faulty.         | Replace the AC contactor.                       |
| 5Err_Sys_Door_Open_Alarm                           | The door is opened.                 | Close the door.                                 |
| 6Err_Sys_Emergency_Stop_Alarm                      | Emergency stop is pressed.          | Release the emergency stop button.              |
| 9Err_Sys_All_Power_Unit_Communication_Failed_Alarm | All power unit communication fault. | Check the communication cable.                  |
| 10Err_Sys_Charging_Station_Over_Temp_Warning       | reserved error                      | -   |
| 11Err_Sys_Charging_Station_Over_Temp_Alarm         | The Air-Cooling Fan Failure.        | Check the Air-Cooling Fan.                      |

| Displaying text  | Fault cause  | Solutions                                |
|--|--|--|
| 0Err_Connector1_Connector_Over_Temp_Warning                            | The Charging connector Failure.                        | Replace the Charging connector.          |
| 1Err_Connector1_Connector_Over_Temp_Alarm                              | Excessive charging current.                            | charging is not affected, keep attention |
| 2Err_Connector1_Insulation_Monitor_Communication_Failed_Alarm          | Communication Failed.                                  | Check the communication cable.           |
| 3Err_Connector1_Insulation_Monitor_Selfcheck_Device_Abnormal_Alarm     | The insulation monitor selfcheck abnormal.             | Please contact SUNGROW Customer service. |
| 4Err_Connector1_Insulation_Monitor_Selfcheck_Wiring_Abnormal_Alarm     | The insulation monitor selfcheck wiring Abnormal.      | Please contact SUNGROW Customer service  |
| 5Err_Connector1_Insulation_Monitor_Selfcheck_DCp_to_GND_Abnormal_Alarm | The insulation monitor selfcheck DC_P to GND Abnormal. | Please contact SUNGROW Customer service  |
| 6Err_Connector1_Insulation_Monitor_Selfcheck_DCn_to_GND_Abnormal_Alarm | The insulation monitor selfcheck DC_N to GND Abnormal. | Please contact SUNGROW Customer service  |
| 7Err_Connector1_DC_Bus_Insulation_Abnormal_Level_1_Alarm               | The DC bus insulation abnormal.                        | Please contact SUNGROW Customer service  |
| 8Err_Connector1_DC_Bus_Insulation_Abnormal_Level_2_Alarm               | The DC bus insulation Warning.                         | Please contact SUNGROW Customer service  |
| 9Err_Connector1_PLC_Module_Communication_Failed_Alarm                  | The PLC module communication failed.                   | Replace the control board.               |
| 10Err_Connector1_Group_of_Power_Units_Failed_Alarm                     | The group of power units Failure.                      | Check the power units state.             |
| 11Err_Connector1_DCp_Output_Contactor_not_Drop_out_Alarm               | The DC contactor is faulty.                            | Replace the DC contactor.                |
| 12Err_Connector1_DCp_Output_Contactor_not_Pick_up_Alarm                | The DC contactor is faulty.                            | Replace the DC contactor.                |
| 13Err_Connector1_DCn_Output_Contactor_not_Drop_out_Alarm               | The DC contactor is faulty.                            | Replace the DC contactor.                |



| Displaying text  | Fault cause                    | Solutions                    |
|--|--------------------------------|------------------------------|
| 14Err_Connector1_DCn_Output_Con-<br>tactor_not_Pick_up_Alarm | The DC contactor is<br>faulty. | Replace the DC<br>contactor. |
| 15Err_Connector1_Reserve15                                   | -                              | -                            |

## 6.3 LLC

table 6-3 LLC Faults and troubleshooting

| Error names                  | Faults cause  | Solutions   |
|------------------------------|---|---|
| EVT_LLC_A_OUTPUT_OV          | Output voltage ex-<br>ceeds the maximum<br>voltage 1000V  | <ol style="list-style-type: none"> <li>1. Check the battery voltage of the<br/>vehicle</li> <li>2. Restart the charger and try<br/>again.</li> <li>3. Please contact SUNGROW cus-<br/>tomer service.</li> </ol> |
| EVT_LLC_A_OUTPUT_UV          | Output voltage falls<br>below the minimum<br>voltage 200V | <ol style="list-style-type: none"> <li>1. Check the battery voltage of the<br/>vehicle</li> <li>2. Restart the charger and try<br/>again.</li> <li>3. Please contact SUNGROW cus-<br/>tomer service.</li> </ol> |
| <u>EVT_LLC_A_OUTPUT_OC</u>   |   | <ol style="list-style-type: none"> <li>1. Check the battery voltage of the<br/>vehicle</li> </ol>   |
| EVT_LLC_A_OUTPUT_<br>SHORT   | -   | <ol style="list-style-type: none"> <li>2. Restart the charger and try<br/>again.</li> <li>3. Please contact SUNGROW cus-<br/>tomer service.</li> </ol>  |
| EVT_LLC_B_OUTPUT_<br>OV      |   | <ol style="list-style-type: none"> <li>1. Check the battery voltage of the<br/>vehicle</li> </ol>   |
| EVT_LLC_B_OUTPUT_<br>OV_FAST | Output voltage ex-<br>ceeds the maximum<br>voltage 1000V  | <ol style="list-style-type: none"> <li>2. Restart the charger and try<br/>again.</li> <li>3. Please contact SUNGROW cus-<br/>tomer service.</li> </ol>  |

| Error names                     | Faults cause  | Solutions   |
|---------------------------------|---|---|
| EVT_LLC_B_OUTPUT_UV             | Output voltage falls below the minimum voltage 200V | <ol style="list-style-type: none"> <li>1. Check the battery voltage of the vehicle</li> <li>2. Restart charger and try again.</li> <li>3. Please contact SUNGROW customer service.</li> </ol>     |
| EVT_LLC_B_OUTPUT_OC             |   | <ol style="list-style-type: none"> <li>1. Check the wiring of DC+ and DC-</li> <li>2. Restart the charger and try again.</li> <li>3. Please contact SUNGROW customer service.</li> </ol>          |
| EVT_LLC_B_OUTPUT_SHORT          | -   | <ol style="list-style-type: none"> <li>1. Check the battery voltage of the vehicle</li> <li>2. Restart the charger and try again.</li> <li>3. Please contact SUNGROW customer service.</li> </ol> |
| EVT_LLC_TOTAL_OV                | Output voltage exceeds the maximum voltage 1000V    | <ol style="list-style-type: none"> <li>1. Check the battery voltage of the vehicle</li> <li>2. Restart the charger and try again.</li> <li>3. Please contact SUNGROW customer service.</li> </ol> |
| EVT_LLC_TOTAL_OC                | Overcurrent   | <ol style="list-style-type: none"> <li>1. Check the wiring of DC+ and DC-</li> <li>2. Restart the charger and try again.</li> <li>3. Please contact SUNGROW customer service.</li> </ol>          |
| EVT_DISCHARGE_CIRCUIT_INVALID   | Internal fault                                      | Please contact SUNGROW customer service.  |
| EVT_RELAY_ADHESION              | Internal fault                                      | Please contact SUNGROW customer service.  |
| EVT_RELAY1_TEMP_SENSOR_INVALID  | Internal fault                                      | Please contact SUNGROW customer service.  |
| EVT_RELAY2_TEMP_SENSOR_INVALID  | Internal fault                                      | Please contact SUNGROW customer service.  |
| EVT_RELAY3_TEMP_SENSOR_INVALID  | Internal fault                                      | Please contact SUNGROW customer service.  |
| EVT_AMBIENT_TEMP_SENSOR_INVALID | Internal fault                                      | Please contact SUNGROW customer service.  |

| Error names                 | Faults cause  | Solutions   |
|-----------------------------|---|---|
| EVT_HS2_TEMP_SENSOR_INVALID | Internal fault  | Please contact SUNGROW customer service.  |
| EVT_HARD_OCP                | Inrush current  | <ol style="list-style-type: none"> <li>1. Check the wiring of DC+ and DC-.</li> <li>2. Restart the charger and try again.</li> <li>3. Please contact SUNGROW customer service.</li> </ol> |
| EVT_SCI_TIMEOUT             | <ol style="list-style-type: none"> <li>1. Internal communication fault</li> <li>2. Internal circuit fault</li> </ol>                                    | <ol style="list-style-type: none"> <li>1. Restart the charger and try again.</li> <li>2. Please contact SUNGROW customer service.</li> </ol>  |
| EVT_CAN_TIMEOUT             | <ol style="list-style-type: none"> <li>1. Internal communication fault</li> <li>2. Internal wiring fault</li> <li>3. Internal circuit fault"</li> </ol> | <ol style="list-style-type: none"> <li>1. Restart the charger and try again.</li> <li>2. Please contact SUNGROW customer service.</li> </ol>  |
| EVT_RELAY1_OTP              | <ol style="list-style-type: none"> <li>1. Internal overflow temperature</li> <li>2. Internal circuit fault"</li> </ol>                                  | <ol style="list-style-type: none"> <li>1. Turn off, waiting for 10 minutes and then restart the charger and try again.</li> <li>2. Please contact SUNGROW customer service.</li> </ol>    |
| EVT_RELAY2_OTP              | <ol style="list-style-type: none"> <li>1. Internal overflow temperature</li> <li>2. Internal circuit fault"</li> </ol>                                  | <ol style="list-style-type: none"> <li>1. Turn off, waiting for 10 minutes and then restart charger and try again.</li> <li>2. Please contact SUNGROW customer service.</li> </ol>        |
| EVT_RELAY3_OTP              | <ol style="list-style-type: none"> <li>1. Internal overflow temperature</li> <li>2. Internal circuit fault"</li> </ol>                                  | <ol style="list-style-type: none"> <li>1. Turn off, waiting for 10 minutes and then restart the charger and try again.</li> <li>2. Please contact SUNGROW customer service.</li> </ol>    |
| EVT_AMBIENT_OTP             | <ol style="list-style-type: none"> <li>1. Internal overflow temperature</li> <li>2. Internal circuit fault"</li> </ol>                                  | <ol style="list-style-type: none"> <li>1. Turn off, waiting for 10 minutes and then restart the charger and try again.</li> <li>2. Please contact SUNGROW customer service.</li> </ol>    |

| Error names                | Faults cause   | Solutions   |
|----------------------------|--|---|
| EVT_HS2_OTP                | <ol style="list-style-type: none"> <li>1. Internal overflow temperature</li> <li>2. Internal circuit fault"</li> </ol>                   | <ol style="list-style-type: none"> <li>1. Turn off, waiting for 10 minutes and then restart charger and try again.</li> <li>2. Please contact SUNGROW customer service.</li> </ol>                            |
| EVT_3V_OV                  | <ol style="list-style-type: none"> <li>1. Internal system voltage exceed normal range</li> <li>2. Internal circuit fault</li> </ol>      | <ol style="list-style-type: none"> <li>1. Check the input voltage whether between normal range</li> <li>2. Restart the charger and try again.</li> <li>3. Please contact SUNGROW customer service.</li> </ol> |
| EVT_3V_UV                  | <ol style="list-style-type: none"> <li>1. Internal system voltage falls below normal range</li> <li>2. Internal circuit fault</li> </ol> | <ol style="list-style-type: none"> <li>1. Check the input voltage whether between normal range</li> <li>2. Restart the charger and try again.</li> <li>3. Please contact SUNGROW customer service.</li> </ol> |
| EVT_12V_OV                 | <ol style="list-style-type: none"> <li>1. Internal system voltage exceed normal range</li> <li>2. Internal circuit fault</li> </ol>      | <ol style="list-style-type: none"> <li>1. Check the input voltage whether between normal range</li> <li>2. Restart charger and try again.</li> <li>3. Please contact SUNGROW customer service.</li> </ol>     |
| EVT_12V_UV                 | <ol style="list-style-type: none"> <li>1. Internal system voltage falls below normal range</li> <li>2. Internal circuit fault</li> </ol> | <ol style="list-style-type: none"> <li>1. Check the input voltage whether between normal range</li> <li>2. Restart the charger and try again.</li> <li>3. Please contact SUNGROW customer service.</li> </ol> |
| EVT_AMBIENT_LOW_TEMP_FAULT | <ol style="list-style-type: none"> <li>1. Internal ambient temperature is too cold</li> <li>2. Internal circuit fault</li> </ol>         | <p>Please contact SUNGROW customer service.</p>   |
| EVT_HS2_LOW_TEMP_FAULT     | <ol style="list-style-type: none"> <li>1. Internal ambient temperature is too cold</li> <li>2. Internal circuit fault</li> </ol>         | <p>Please contact SUNGROW customer service.</p>   |

| Error names            | Faults cause                       | Solutions  |
|------------------------|------------------------------------|--|
| EVT_HARD_OUTPUT_SHORT  | Overcurrent                        | <ol style="list-style-type: none"> <li>1. Check the wiring of DC+ and DC-</li> <li>2. Restart the charger and try again.</li> <li>3. Please contact SUNGROW customer service.</li> </ol> |
| EVT_HARD_VERSION_ERROR | Software version is not compatible | Please contact SUNGROW customer service.   |

## 6.4 PFC

table 6-4 PFC Faults and troubleshooting

| Errors names    | Fault cause               | Solutions   |
|-----------------|---------------------------|---|
| BUSVoltageHigh  | Internal fault            | 1. Restart the charger and try again.   |
| PBUSVoltageHigh |                           | 2. Please contact SUNGROW customer service.   |
| NBUSVoltageHigh |                           |   |
| IAPeakHigh      | Input over current        | 1. Restart the charger and try again.   |
| IBPeakHigh      |                           | 2. Please contact SUNGROW customer service.   |
| ICPeakHigh      |                           |   |
| PhaseSeqWrong   | Input voltage phase fault | <ol style="list-style-type: none"> <li>1. Check the wiring of input voltage</li> <li>2. Restart the charger and try again.</li> <li>3. Please contact SUNGROW customer service.</li> </ol>                                |
| PhaseLoss       | Input voltage phase lost  | <ol style="list-style-type: none"> <li>1. Check the wiring of input voltage and the value of input voltage</li> <li>2. Restart the charger and try again.</li> <li>3. Please contact SUNGROW customer service.</li> </ol> |

| Errors names        | Fault cause  | Solutions   |
|---------------------|--|---|
| AmbientTempHgih     | High internal temperature                                    | 1. Turn off, waiting for 10 minutes and then Restart the charger and try again.<br>2. Please contact SUNGROW customer service.                  |
| RadiatorATempHgih   |  |   |
| RadiatorBTempHgih   |  |   |
| RadiatorCTempHgih   |  |   |
| BUSPreChargeVolLow  | Internal fault   | 1. Restart the charger and try again.<br>2. Please contact SUNGROW customer service.  |
| PBUSPreChargeVolLow |  |   |
| NBUSPreChargeVolLow |  |   |
| BUSVoltageLow       |  |   |
| AmbientTempLow      | Low internal temperature                                     | 1. Restart the charger and try again.<br>2. Please contact SUNGROW customer service.  |
| RadiatorATempLow    |  |   |
| RadiatorBTempLow    |  |   |
| RadiatorCTempLow    |  |   |
| PhaseACurrenRmsHigh | High input current   | 1. Restart the charger and try again.<br>2. Please contact SUNGROW customer service.  |
| PhaseBCurrenRmsHigh |  |   |
| PhaseCCurrenRmsHigh |  |   |
| InputRelayFail      | Internal AC relay fault                                      | 1. Restart the charger and try again.<br>2. Please contact SUNGROW customer service.  |
| PowerSupplyAbnorma  | Internal system voltage fault                                | 1. Check the input voltage whether between normal range<br>2. Restart the charger and try again.<br>3. Please contact SUNGROW customer service. |
| SCIfault            | 1. Internal communication fault<br>2. Internal circuit fault | 1. Restart the charger and try again.<br>2. Please contact SUNGROW customer service.  |
| HardWearOCPFault    | Input over current   | 1. Restart the charger and try again.<br>2. Please contact SUNGROW customer service.  |

| Errors names       | Fault cause  | Solutions   |
|--------------------|--|---|
| SWUVPFault         | Internal fault                                       | 1. Restart the charger and try again.<br>2. Please contact SUNGROW customer service.                              |
| LLCVersionNotMatch | Software version is not compatible                   | Please contact SUNGROW customer service.  |
| GridAVolHigh       | High AC input grid voltage, normal range AC 360~440V | 1. Check the AC input voltage   |
| GridBVolHigh       |  | 2. Restart the charger and try again.   |
| GridCVolHigh       |  | 3. Please contact SUNGROW customer service.   |
| GridAVolLow        | Low AC input grid voltage, normal range AC 360~440V  | 1. Check the AC input voltage   |
| GridBVolLow        |  | 2. Restart the charger and try again.   |
| GridCVolLow        |  | 3. Please contact SUNGROW customer service.   |
| FreqHigh           | AC input frequency over normal range 45HZ~55HZ       | 1. Check the AC input voltage   |
| FreqLow            |  | 2. Restart the charger and try again.   |
| GridCutFastProtect | AC input voltage lost                                | 3. Please contact SUNGROW customer service.   |
| SpIIFault          | Internal fault                                       | 1. Check the AC input voltage<br>2. Restart charger and try again.<br>3. Please contact SUNGROW customer service. |
| InPutVoltageDroop  | AC input voltage fault                               | 1. Restart the charger and try again.<br>2. Please contact SUNGROW customer service.                              |

| Errors names            | Fault cause        | Solutions  |
|-------------------------|--------------------|--|
| BUSVoltageContinueHigh  | Internal fault     | 1. Restart the charger and try again.<br>2. Please contact SUNGROW customer service. |
| PBUSVoltageContinueHigh |                    |  |
| NBUSVoltageContinueHigh |                    |  |
| BUSVoltageDiscreteHigh  |                    |  |
| PBUSVoltageDiscreteHigh |                    |  |
| NBUSVoltageDiscreteHigh |                    |  |
| BusRippleOver           |                    |  |
| PBusRippleOver          |                    |  |
| NBusRippleOver          |                    |  |
| InPutCurrUnbal          |                    |  |
| Fan1Speedabnormal       | Internal fan fault | 1. Restart the charger and try again.<br>2. Please contact SUNGROW customer service. |
| Fan2Speedabnormal       |                    |  |
| Fan3Speedabnormal       |                    |  |
| Fan4Speedabnormal       |                    |  |
| Fan5Speedabnormal       |                    |  |
| InputVoltUnbal          | Internal fault     | 1. Restart the charger and try again.<br>2. Please contact SUNGROW customer service. |



## 6.5 Charging Stop Code

table 6-5 Charging stop code

| Fault name                   | Displaying text    | Fault cause   | Solutions   |
|------------------------------|--------------------|---|---|
| EV emergency stop            | EV_E_Stop          | An error has occurred, the charging session is terminated by the vehicle forcefully | <ol style="list-style-type: none"> <li>1. Plug out the charging connector, re-plug it into the vehicle, and try to restarting the charging session again.</li> <li>2. If the problem persists, restart the charger, and repeat step 1.</li> <li>3. If the problem still persists, please contact SUNGROW customer service</li> </ol>  |
| PWM failure                  | PWM_Failure        | The PWM is invalid on the CP-PE interface   | Please contact SUNGROW customer service   |
| EV reports a fault and stops | EV_Reported_Error  | An error has occurred in the vehicle side, the charging session terminates          | <ol style="list-style-type: none"> <li>1. Plug out the charging connector, re-plug it into the vehicle, and try to restarting the charging session again.</li> <li>2. If the problem persists, restart the charger, and repeat step 1.</li> <li>3. If the problem still persists, please contact SUNGROW customer service.</li> </ol> |
| SLAC match failure           | SLAC_Match_Failure | The charging session handshake - SLAC process failed                                | <ol style="list-style-type: none"> <li>1. Plug out the charging connector, re-plug it in the vehicle, and try to restarting a charging session again</li> <li>2. If the problem persists, restart the charger, and repeat step 1.</li> <li>3. If the problem still persists, please contact SUNGROW customer service"</li> </ol>      |

| Fault name            | Displaying text               | Fault cause  | Solutions   |
|-----------------------|-------------------------------|--|---|
| SDP handshake failure | SDP_<br>Handshake_<br>Failure | The charging session handshake - SDP process failed                            | <ol style="list-style-type: none"> <li>1. Plug out the charging connector, re-plug it in the vehicle, and try to restarting a charging session again</li> <li>2. If the problem persists, restart the charger, and repeat step 1.</li> <li>3. If the problem still persists, please contact SUNGROW customer service"</li> </ol>  |
| UDP server fault      | UDpv6_<br>Server_Fault        | The charging session handshake - UDP server during SDP process is invalid      | <ol style="list-style-type: none"> <li>1. Plug out the charging connector, re-plug it in the vehicle, and try to restarting a charging session again</li> <li>2. If the problem persists, restart the charger, and repeat step 1.</li> <li>3. If the problem still persists, please contact SUNGROW customer service"</li> </ol>  |
| TCP server fault      | TCPIPv6_<br>Server_Fault      | The charging session handshake - TCP server during charging process is invalid | <ol style="list-style-type: none"> <li>1. Plug out the charging connector, re-plug it in the vehicle, and try to restarting a charging session again.</li> <li>2. If the problem persists, restart the charger, and repeat step 1.</li> <li>3. If the problem still persists, please contact SUNGROW customer service"</li> </ol> |

| Fault name                              | Displaying text                          | Fault cause   | Solutions  |
|---|--|---|--|
| Protocol handshake failure              | Protocol_<br>Handshake_<br>Failure       | The charging session handshake - protocol handshake (DIN/ISO15118) failed | <ol style="list-style-type: none"> <li>1. Plug out the charging connector, re-plug it in the vehicle, and try to restarting a charging session again</li> <li>2. If the problem persists, restart the charger, and repeat step 1.</li> <li>3. If the problem still persists, please contact SUNGROW customer service.</li> </ol> |
| Service parameter incompatibility       | Service_<br>Incompatibility              | The charging session - service parameter exchange failed                  | <ol style="list-style-type: none"> <li>1. Plug out the charging connector, re-plug it in the vehicle, and try to restarting a charging session again</li> <li>2. If the problem persists, restart the charger, and repeat step 1.</li> <li>3. If the problem still persists, please contact SUNGROW customer service</li> </ol>  |
| Communication parameter incompatibility | Charge_<br>Parameter_<br>Incompatibility | The charging session - service parameter exchange failed                  | <ol style="list-style-type: none"> <li>1. Plug out the charging connector, re-plug it in the vehicle, and try to restarting a charging session again</li> <li>2. If the problem persists, restart the charger, and repeat step 1.</li> <li>3. If the problem still persists, please contact SUNGROW customer service.</li> </ol> |

| Fault name           | Displaying text      | Fault cause  | Solutions  |
|----------------------|----------------------|--|--|
| Cable check fault    | Cable_Check_Fault    | The charging session - cableCheck process failed     | <ol style="list-style-type: none"> <li>1. Plug out the charging connector, re-plug it in the vehicle, and try to restarting a charging session again</li> <li>2. If the problem persists, restart the charger, and repeat step 1.</li> <li>3. If the problem still persists, please contact SUNGROW customer service.</li> </ol> |
| Precharge fault      | Precharge_Fault      | The charging session - precharge process failed      | <ol style="list-style-type: none"> <li>1. Plug out the charging connector, re-plug it in the vehicle, and try to restarting a charging session again</li> <li>2. If the problem persists, restart the charger, and repeat step 1.</li> <li>3. If the problem still persists, please contact SUNGROW customer service.</li> </ol> |
| Current demand fault | Current_Demand_Fault | The charging session - current demand process failed | <ol style="list-style-type: none"> <li>1. Plug out the charging connector, re-plug it in the vehicle, and try to restarting a charging session again</li> <li>2. If the problem persists, restart the charger, and repeat step 1.</li> <li>3. If the problem still persists, please contact SUNGROW customer service.</li> </ol> |

| Fault name                       | Displaying text                  | Fault cause   | Solutions   |
|----------------------------------|----------------------------------|---|---|
| CP voltage abnormal              | CP_Voltage_Abnormal              | The CP-PE terminal voltage is abnormal  | <ol style="list-style-type: none"> <li>1. Plug out the charging connector, re-plug it in the vehicle, and try to restarting a charging session again</li> <li>2. If the problem persists, restart the charger, and repeat step 1.</li> <li>3. If the problem still persists, please contact SUNGROW customer service.</li> </ol>  |
| DC output overvoltage protection | DC_Output_Overvoltage_Protection | DC output voltage is over 1020V, the charger over-voltage protection is triggered | <ol style="list-style-type: none"> <li>1. Check the output voltage on the vehicle or the charger during the charging session, if the voltage is over 1020V, the charging will not be successful. In this case, please contact the SUNGROW customer service and do not proceed the next steps</li> <li>2. Plug out the charging connector, re-plug it in the vehicle, and try to restarting a charging session again</li> <li>3. If the problem persists, restart the charger, and repeat step 1.</li> <li>4. If the problem still persists, please contact SUNGROW customer service"</li> </ol> |

| Fault name                        | Displaying text                     | Fault cause   | Solutions   |
|-----------------------------------|-------------------------------------|---|---|
| DC output undervoltage protection | DC_Output_ Undervoltage_ Protection | DC output voltage is under 195V, the charger undervoltage protection is triggered | <ol style="list-style-type: none"> <li>1. Check the output voltage on the vehicle or the charger during the charging session, if the voltage is under 195V, the charging will not be successful. In this case, please contact SUNGROW customer service and do not proceed the next steps</li> <li>2. Plug out the charging connector, re-plug it in the vehicle, and try to restarting a charging session again</li> <li>3. If the problem persists, restart the charger, and repeat step 1.</li> <li>4. If the problem still persists, please contact SUNGROW customer service.</li> </ol> |
| DC output overcurrent protection  | DC_Output_ Overcurrent_ Protection  | DC output current is over 82A, the charger over-current protection is triggered   | <ol style="list-style-type: none"> <li>1. Check the output current on the vehicle or the charger during the charging session, if the current is over 82 A, the charging will not be successful. In this case, please contact SUNGROW customer service and do not proceed the next steps</li> <li>2. Plug out the charging connector, re-plug it in the vehicle, and try to restarting a charging session again</li> <li>3. If the problem persists, restart the charger, and repeat step 1.</li> <li>4. If the problem still persists, please contact SUNGROW customer service.</li> </ol>  |

| Fault name                   | Displaying text                  | Fault cause   | Solutions  |
|------------------------------|----------------------------------|---|--|
| Frame communication timeout  | Frame_<br>Communication_Timeout  | The communication between the charger and the vehicle is not stable, or the charger/vehicle failed to send message    | <ol style="list-style-type: none"> <li>1. Plug out the charging connector, re-plug it in the vehicle, and try to restarting a charging session again</li> <li>2. If the problem persists, restart the charger, and repeat step 1.</li> <li>3. If the problem still persists, please contact SUNGROW customer service.</li> </ol> |
| Communication sequence fault | Communication_Sequence_<br>Fault | The communication frame sent by the vehicle does not follow the sequence defined in the DIN SPEC 70121/ISO 15118 norm | <ol style="list-style-type: none"> <li>1. Plug out the charging connector, re-plug it in the vehicle, and try to restarting a charging session again</li> <li>2. If the problem persists, restart the charger, and repeat step 1.</li> <li>3. If the problem still persists, please contact SUNGROW customer service.</li> </ol> |

# 7 System Maintenance

## 7.1 Inspection Instructions

It is suggested to perform regular inspections on the charger, so as to extend its service life. The inspection interval should be determined with on-site conditions taken into consideration. In case the product works in extreme weather conditions, be sure to shorten the inspection interval and increase inspection frequency.

- Before inspection, switch off the AC opening, and wait 10 minutes until no voltage is present. Then, you may open the cover plate for inspection.
- In case of a fault with the device, contact your local service provider or manufacturer immediately. Do not open the device without permission.
- If some devices need to be replaced during the inspection, please contact SUNGROW.
- Losses caused by failing to perform inspections in compliance with the instructions specified in this manual will not be covered by the warranty.
- Do not perform inspections on the product on rainy, humid, or windy days. SUNGROW shall not be held liable for any possible outcome resulted from inspections in such weather conditions.
- To reduce the risk of electric shocks, do not perform inspections that are not specified in this manual. If needed, please contact SUNGROW for inspection and repair services. Otherwise, damages caused therefrom will not be covered by the warranty.

## 7.2 Routine Inspection

It is recommended to perform routine inspections on the product once every 6 months. However, the actual inspection interval is subject to the charger's operating environment.



| Inspection Item                       | Inspection Method   | Recommended Inspection Interval |
|---------------------------------------|---|---------------------------------|
| Charger exterior                      | <ul style="list-style-type: none"> <li>• Check if there is any deformation with the charger enclosure.</li> <li>• Check if there is paint peeling on the charger's exterior.</li> <li>• Check if the nameplate and marks on the charger are all legible.</li> <li>• Check if there is anything abnormal with the exterior of peripheral components such as the charging connector holder and antenna.</li> </ul>                    | Once every 6 months             |
| Charger structure                     | <ul style="list-style-type: none"> <li>• Check if the parts and components of the charger are secure and reliable.</li> <li>• Check if there is any damage to the internal power units, main control board, auxiliary low-voltage power supply, charging interface, and power supply interface.</li> <li>• Clean the dust-proof fabric and dirt and dust inside the charger, and check if there is any wet spot.</li> </ul>         | Once every 6 months             |
| Charging connector and charging cable | <ul style="list-style-type: none"> <li>• Check the charging connector for any foreign matters. Ensure the pins inside the connector are clean without dirt. Clean off the foreign matters, if any, in time.</li> <li>• Check the charging connector and charging cable for deficiency, crack, abrasion, damage, wire exposure, etc.</li> </ul>  | Once every 6 months             |
| Electrical Connection                 | <ul style="list-style-type: none"> <li>• Check if the electrical line is burnt or has aged and if the fixing screws are loose.</li> <li>• Check whether the grounding cable is properly connected to allow for reliable grounding.</li> <li>• Check the cables for deficiency, crack, abrasion, damage, wire exposure, etc.</li> <li>• Other inspection items can be arranged based on the actual situation on the site.</li> </ul> | Once every 6 months             |

| Inspection Item | Inspection Method  | Recommended Inspection Interval |
|-----------------|--|---------------------------------|
| LCD Screen      | <ul style="list-style-type: none"> <li>• Check the display of the screen for broken or cracks.</li> <li>• Check the brightness of the screen and whether the display definition is normal.</li> <li>• Click the screen to operate and check whether the touch function is normal.</li> <li>• Check the waterproof performance around the screen and the plastic panel.</li> </ul>  | Once every 6 months             |
| Fan             | <ul style="list-style-type: none"> <li>• Check whether there is foreign object inside the fan and the fan openings. Clean the dust with water to prevent the accumulation dust from affecting the heat dissipation. The water flow should be less than 6L/min.</li> <li>• Check whether the fan is running normally during operation.</li> <li>• In device standby status, select factory mode operation to operate the fan at full speed, and check whether the fan speed is normal.</li> </ul> | Once every 6 months             |

# 8 Appendix

## 8.1 System Parameters

table 8-1 System parameters

| Technical parameters             | IDC30E (For Europe)            | IDC30E (For Australia) |
|----------------------------------|--------------------------------|------------------------|
| <b>Charging connector</b>        |                                |                        |
| Connector type                   | CCS2                           |                        |
| EVSE-vehicle protocol            | DIN SPEC 70121, ISO 15118      | DIN SPEC 70121         |
| Number of EV served              | 1                              |                        |
| Cable length                     | 5 m                            |                        |
| <b>DC Output</b>                 |                                |                        |
| DC output power                  | 30 kW                          |                        |
| DC output voltage                | 200 Vdc - 1000 Vdc             |                        |
| DC output current                | 80 A                           |                        |
| <b>AC Input</b>                  |                                |                        |
| Grid voltage                     | 3 / N / PE, 400 Vac ( ± 10 % ) |                        |
| Nominal grid frequency           | 50 Hz                          |                        |
| Grid frequency range             | 45 Hz - 55 Hz                  |                        |
| Earthing system                  | TN-C, TN-S, TN-C-S, TT         |                        |
| Nominal input current            | 46 A                           |                        |
| Max. input current               | 52 A                           |                        |
| Power factor                     | ≥ 0.99                         |                        |
| Total harmonic distortion (THDi) | < 5 % at full output power     |                        |
| Overvoltage category             | III                            |                        |

| <b>Technical parameters</b>              | <b>IDC30E (For Europe)</b>  | <b>IDC30E (For Australia)</b>       |
|--|---|-------------------------------------|
| <b>Efficiency</b>                        |   |                                     |
| Max. efficiency                          | 96.5%   |                                     |
| <b>Protection</b>                        |   |                                     |
| Over / under voltage protection          | Yes   |                                     |
| Over-current protection                  | Yes   |                                     |
| Short-circuit protection                 | Yes   |                                     |
| Over-temperature protection              | Yes   |                                     |
| Surge protection                         | Yes   |                                     |
| <b>User interface</b>                    |   |                                     |
| Display                                  | 7-inch color touch screen   |                                     |
| Language                                 | English ( default )<br>Other languages available by firmware upgrade                            |                                     |
| Authentication                           | RFID-card, Plug & Play, Auto-charge ( default )<br>Plug & Charge, Payment terminal ( optional ) | RFID-card, Plug & Play, Auto-charge |
| Firmware update                          | Over-the-air ( OTA ) by iEnergyCharge   |                                     |
| RFID system                              | ISO / IEC 14443 A / B, ISO / IEC 15693  |                                     |
| Energy metering                          | MID metering ( CE compliant )<br>Eichrecht / PTB compliant ( optional )                         | DC metering ( CE compliant )        |
| Communication interface                  | 4G, Ethernet, WLAN  |                                     |
| Communication protocol (charger-to-CSMS) | OCPP 1.6 J<br>Ready for OCPP 2.0.1  |                                     |
| Emergency stop                           | Yes, integrated   |                                     |
| <b>Mechanical data</b>                   |   |                                     |
| Dimensions (W*H*D)                       | 500 mm * 800 mm * 288 mm  | 500 mm * 800 mm * 242 mm            |

| <b>Technical parameters</b>         | <b>IDC30E (For Europe)</b>   | <b>IDC30E (For Australia)</b> |
|-------------------------------------|--|-------------------------------|
| Weight                              | ≤ 57 kg  | 53 kg                         |
| Installation method                 | Wall-mounting ( default )<br>Stand column, trolley ( optional )  |                               |
| Mechanical impact protection        | IK10 *   |                               |
| <b>Environmental data</b>           |  |                               |
| Degree of protection                | IP65   |                               |
| Anti-corrosion degree               | C5   |                               |
| Operating ambient temperature range | -35 °C ~ 55 °C   |                               |
| Allowable relative humidity range   | 5 % ~ 95 % ( non-condensing )  |                               |
| Max. operating altitude             | ≤ 2000 m   |                               |
| Cooling method                      | Smart forced air cooling   |                               |
| Noise (typical)                     | ≤ 50 dB ( A )  |                               |
| EMC                                 | Class B  |                               |
| <b>General data</b>                 |  |                               |
| Compliance                          | EN IEC 62311, EN IEC 61851-1 / 21, EN IEC 61000-6-1 / 2 / 3 / 4, EN 61851-23 / 24, EN 301 908-1 / 2 / 13, EN 301 511, EN 301 489 -1 / 3 / 17 / 52, ESTI / EN 300 330, ESTI / EN 300 328, IEC 61851-1 / 23 / 24, DIN SPEC 70121, DIN SPEC 70122 |                               |
| Warranty                            | 3 years ( standard )   |                               |
| Country of manufacture              | -  | Made in China                 |

\*The mechanical impact protection degree of HMI is IK08.

## 8.2 Quality Assurance

When product faults occur during the warranty period, SUNGROW will provide free service or replace the product with a new one.

### **Evidence**

During the warranty period, the customer shall provide the product purchase invoice and date. In addition, the trademark on the product shall be undamaged and legible. Otherwise, SUNGROW has the right to refuse to honor the quality guarantee.

### **Condition**

- After replacement, unqualified products shall be processed by SUNGROW.
- The customer shall give SUNGROW a reasonable period to repair the faulty device.

### **Exclusion of Liability**

In the following circumstances, SUNGROW has the right to refuse to honor the quality guarantee:

- The voltage ratings used by the customers must meet the requirements of the charger. SUNGROW shall not be liable for the loss caused by mismatching.
- Be sure to use the charger reasonably and correctly in strict accordance with the parameters described in this manual (such as voltage, etc.). Otherwise, you shall be responsible for the consequences arising therefrom.
- Be sure to waterproof the empty terminals in strict accordance with the requirements specified in this manual. If the protection level of the charger is reduced due to improper handling, SUNGROW will not be responsible.
- The free warranty period for the whole machine and components has expired.
- Equipment damage during transportation.
- Incorrect installation, refitted, or use of the product
- Operation in a harsh environment is not described in this manual.
- Machine failure or damage caused by installation, repair, alteration, or disassembly not conducted by the service agencies or personnel of SUNGROW.
- Machine failure or damage caused by installation, repair, alteration, or disassembly not conducted by qualified service personnel or SUNGROW staff.
- Damage caused by abnormal natural environment or man-made damage.

If the product fault arises due to any of the above causes and the customer requires repair services, such a service may be provided at a cost, following the assessment of SUNGROW.

### **Software Authorization**

The company is not liable for any loss caused by the software products provided with the products.

- It is prohibited to use some or all of the data in the firmware or software developed by SUNGROW for commercial purposes in any way.

- It is forbidden to decompile, decrypt, or other operations that destroy the original program design of the software developed by SUNGROW.

### 8.3 Contact Information

In case of questions about this product, please contact us.

We need the following information to provide you the best assistance:

- Model of the device
- Serial number of the device
- Fault code/name
- Brief description of the problem

For detailed contact information, please visit: <https://en.sungrowpower.com/contactUS>

**SUNGROW**

Sungrow Power Supply Co., Ltd.  
[www.sungrowpower.com](http://www.sungrowpower.com)